

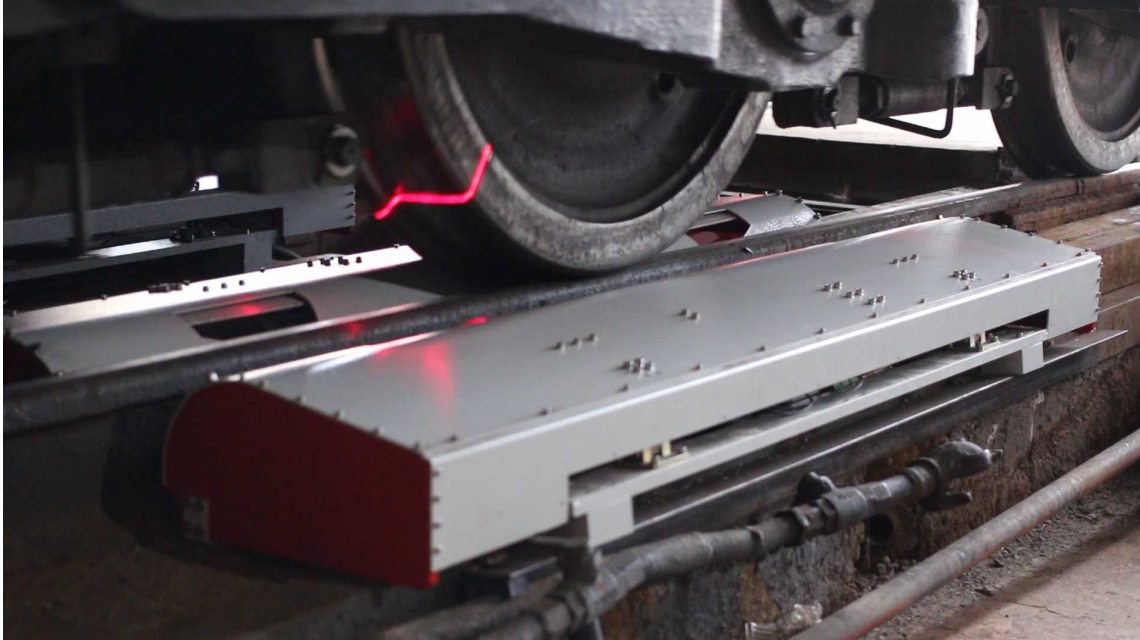

RIFTEK

Sensors & Instruments



REAL TIME WHEELS GEOMETRY MEASUREMENT SYSTEM

3DWheel Series

User's manual

22, Logoisky tract, Minsk
220090, Republic of Belarus
tel/fax: +375 17 357 36 57
info@riftek.com
www.riftek.com

Contents

1.	Safety precautions and measurement conditions.....	4
2.	CE Compliance.....	4
3.	Laser safety.....	4
3.1.	Class 3B scanners.....	4
3.2.	Class 2M scanners.....	4
4.	General information.....	5
5.	Basic technical data.....	6
6.	Structure and operating principle.....	7
6.1.	Laser scanning modules.....	8
6.2.	Air conditioning and protection module.....	12
6.3.	Position monitoring module.....	12
6.4.	Identification module.....	13
6.5.	Control, communication and power module.....	14
7.	Geometric parameters of the wheel under control.....	15
7.1.	Measurement constraints.....	15
7.1.1.	Longitude shift.....	15
7.1.2.	Lateral shift.....	15
7.1.3.	Misalignment, X axis.....	15
7.1.4.	Misalignment, Z axis.....	16
7.2.	Measured parameters.....	16
7.2.1.	Flange height, sH.....	16
7.2.2.	Flange thickness, sD.....	16
7.2.3.	Flange slope, qR.....	17
7.2.4.	Root wear, sWr.....	18
7.2.5.	Wheel tread hollow, Hl.....	18
7.2.6.	Wheel rim thickness, sT.....	18
7.2.7.	Flange rollover, Rf.....	19
7.2.8.	Tread rollover, Rt.....	19
7.2.9.	Wheel diameter, D.....	19
7.2.10.	Wheel width, L.....	20
7.2.11.	Back-to-back distance, B2B.....	20
7.2.12.	Wheel chamfer, Wc.....	20
7.2.13.	Tread taper, Tt.....	20
8.	Intended use.....	21
8.1.	Preparation for use.....	21
8.1.1.	Visual inspection.....	21
8.1.2.	System installation.....	21
8.1.2.1.	Mounting place.....	21
8.1.2.2.	Equipment installation.....	21
8.1.3.	Switching on the system.....	22
8.1.4.	Calibration.....	22
8.2.	Operating the system.....	25
9.	Railway administration software.....	25
9.1.	System requirements.....	25
9.2.	Starting up.....	26
9.3.	Database connection.....	26
9.4.	Main window.....	26
9.4.1.	"BASIC WIZARDS" tab.....	26
9.4.1.1.	Users.....	26
9.4.1.2.	Wheel Types.....	28
9.4.1.3.	Wheel Pair Types.....	30
9.4.1.4.	Car Types.....	32
9.4.1.5.	Wheel Measurement Types.....	34
9.4.1.6.	Wheel Pair Measurement Types.....	34

9.4.1.7.	Math Parameters.....	35
9.4.1.8.	Notification Emails.....	36
9.4.2.	"MEASUREMENTS" tab.....	36
9.4.2.1.	Measurement results.....	37
9.4.2.1.1.	Tabular form.....	37
9.4.2.1.2.	Graphical form.....	38
9.4.2.2.	Wheel profile.....	38
9.4.2.3.	Sorting and filtering.....	39
9.5.	Data export.....	39
9.5.1.	Data export formats.....	39
9.5.2.	Examples	39
9.5.2.1.	CSV	39
9.5.2.2.	XLSX	40
9.5.2.3.	JSON	41
9.6.	Prediction of repair date.....	42
9.7.	Program settings.....	44
9.8.	Keyboard shortcuts.....	45
10.	Riftek API.....	45
11.	Annex 1. Controller RF700.....	47
12.	Warranty policy.....	48
13.	Revisions.....	48
14.	Distributors.....	48
15.	RIFTEK's measurement devices for railway transport.....	53

1. Safety precautions and measurement conditions

- Use supply voltage and interfaces indicated in the system specifications.
- In connection/disconnection of cables, the system power must be switched off.
- The system must be grounded. All power cables must be shielded.

2. CE Compliance

The system has been developed for use in industry and meets the requirements of the following Directives:

- EU directive 2014/30/EU (Electromagnetic compatibility).

3. Laser safety

The 3DWheel system contains laser scanners RF627, which correspond to the 2M or 3B safety classes according to IEC/EN 60825-1:2014.

3.1. Class 3B scanners

The scanners make use semiconductor laser. Maximum output power is 50 mW. The scanners belong to the 3B laser safety class. The following warning label is placed on the scanner housing:

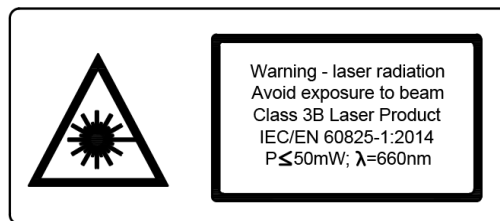

The following safety measures should be taken while operating the scanners:

- Do not target laser beam to humans.
- Avoid staring into the laser beam through optical instruments.
- Mount the scanner so that the laser beam is positioned above or below the eyes level.
- Mount the scanner so that the laser beam does not fall onto a mirror surface.
- Use protective goggles while operating the scanner.
- Avoid staring at the laser beam going out of the scanner and the beam reflected from a mirror surface.
- Do not disassemble the scanner.
- Use the laser deactivation function in emergency.

3.2. Class 2M scanners

The scanners make use of an c.w. 660 nm or 405 wavelength semiconductor laser. Maximum output power is 1 mW. The sensors belong to the 2M laser safety class. The following warning label is placed on the scanner housing:

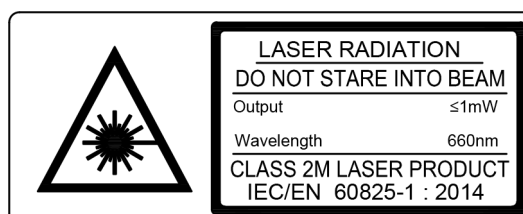

The following safety measures should be taken while operating the scanners:

- Do not target laser beam to humans.
- Do not disassemble the scanner.
- Avoid staring into the laser beam.

4. General information

The 3DWheel system is designed for non-contact automatic measurement of geometrical parameters of wheelsets. The system uses a combination of 2D laser scanners RF627 Series mounted wayside in the track area and calibrated into one common coordinate system. All measurements are performed in the real-time mode.

The main advantages of the system are as follows:

- Measurements are performed on moving trains.
- A modular structure allows to configure the system to customer's requirements (landscape, climatic and technical conditions).
- Automatic recognition of the train number and automatic start of the measurement process.
- Non-contact measurement method.
- Taking a full profile of the wheel rolling surface.
- Control of geometrical parameters of railway wheels:
 - Wheel profile
 - Flange height
 - Flange thickness
 - Flange slope
 - Root wear
 - Wheel tread hollow
 - Wheel rim thickness
 - Flange rollover
 - Tread rollover
 - Wheel diameter
 - Wheel width
 - Back-to-back distance
- Generating reports in CSV format with the ability to export data to other systems (integration into existing infrastructure).
- Ability to receive data by email or SMS.
- Electronic database of the railway wheels wear.
- Autonomous operation - there is no need to control the measurement process.
- The system is virtually maintenance free.
- The system is very easy to install due to a modular structure.
- The system has protection against climatic and technogenic factors such as rain, snow, dust, lubricating fluid.

5. Basic technical data

Measurement range			
Parameter	Value		
Flange height, mm	20...45		
Flange thickness, mm	20...50		
Flange slope, mm	1...15		
Rim thickness, mm	30...100		
Tire width, mm	20...120		
Wheel diameter, mm	400...1400		
Back-to-back distance, mm	according to the track width		
Measurement error			
Parameter	3DWheel.10 Train speed up to 10 km/h	3DWheel.60 Train speed up to 60 km/h	3DWheel.120 Train speed up to 120 km/h
Flange height, mm	± 0.2	± 0.4	± 0.6
Flange thickness, mm	± 0.2	± 0.4	± 0.6
Flange slope / qR factor, mm	± 0.2	± 0.4	± 0.6
Rim thickness, mm	± 0.5	± 0.5	± 1.0
Wheel width / Rim width, mm	± 0.3	± 0.5	± 1.0
Wheel diameter, mm	± 0.5	± 0.5	± 1.0
Back-to-back distance, mm	± 0.3	± 0.5	± 1.0
Other technical data			
Parameter	Value		
Power supply (control cabinet), V	220 (AC)		
Power supply (air conditioning system), V	380 (AC)		
Power consumption (control cabinet), kW	1 (voltage 220, 50 Hz)		
Power consumption (air conditioning system), kW	summer: 3 (voltage 380) winter: up to 16 (voltage 380)		
Operating temperature, °C	0...+50		
Relative humidity, %	5-95 (no condensation)		
Enclosure rating	IP67		

NOTE: System parameters can be changed for a specific task.

6. Structure and operating principle

The 3DWheel system has a modular and open configuration, which makes it possible to adapt it to any types of railroad tracks and railway wheels, and to reduce the technical maintenance to a minimum.

A functional diagram of the system is shown in Figure 1.

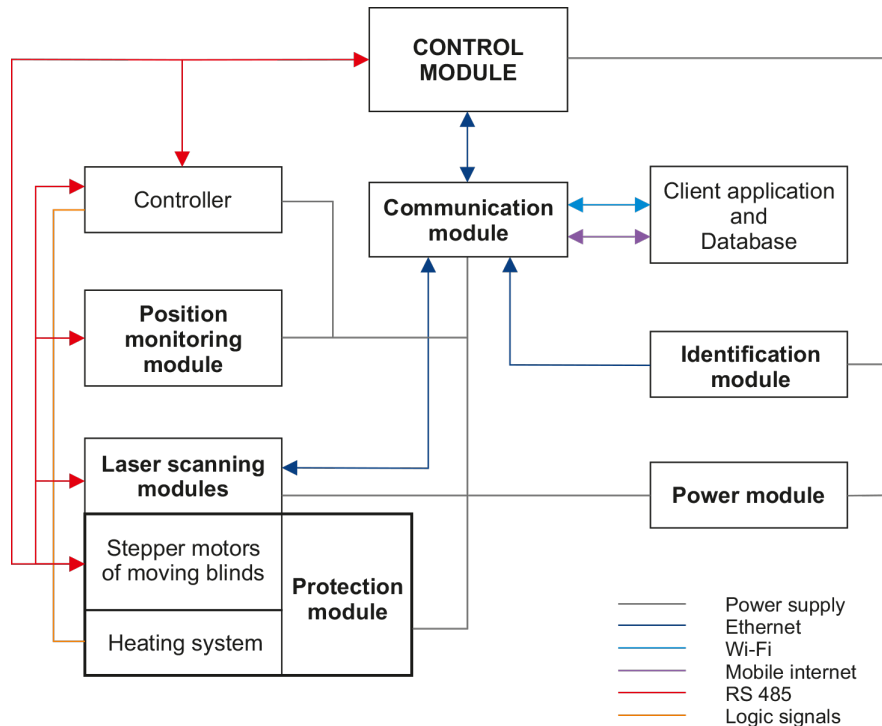

Figure 1

The main modules of the 3DWheel system are as follows:

1) **Laser scanning modules**. These modules are intended for scanning of the wheelset. They contain 2D laser scanners RF627 Series mounted wayside in the track area and calibrated into one common coordinate system.

2) **Air conditioning and protection module**. It is intended to maintain a stable temperature inside laser scanning modules, and for mechanical protection of laser scanners against any possible damage and contamination.

3) **Position monitoring module**. It is intended to monitor the position of the wheel relative to the laser scanning modules. This module contains inductive sensors mounted wayside in the track area, which run the scanning process when the wheelset is detected.

4) **Identification module**. It is intended to identify the train number. The module contains the RFID registration system.

5) **Control module**. It is intended to coordinate the operation of all modules of the system, to gather data, to create a mathematical model of the wheel profile, to calculate required geometrical parameters, and to generate reports to send to the operator.

6) **Communication module**. It is intended for remote access to the 3DWheel system in order to test it, to change settings, and to transmit data to depot.

7) **Power module**. It is intended to provide a stable power supply of all 3DWheel modules. It guarantees the uninterruptible power supply for 60 minutes in a case when an external mains voltage is lost.

The 3DWheel system also includes a controller of RF700 series (see [Annex 1](#)). It controls the air conditioning cabinet, the power of the laser scanning modules and HTC boards in scanners, as well as the power of the moving blinds. It processes signals from four inductive sensors and generates sync pulses for scanners.

The 3DWheel system operates as follows:

- The **Position monitoring module** detects the rolling stock.
- When the rolling stock is detected, the **Control module** turns on the **Laser scanning modules** and opens the protective blinds.
- The **Identification module** recognizes the train number.
- The **Position monitoring module** detects the wheels, and the **Laser scanning modules** start the scanning process.
- The **Laser scanning modules** are taking the wheel profiles, when the wheelset is going through the control area.
- Data gathered from all scanners are transmitted to the **Control module** for calculation of geometrical parameters of the wheels.
- The received data are grouped and the **Communication module** sends them to the client application and to the database.

6.1. Laser scanning modules

Laser scanning modules consist of a combination of 2D laser scanners RF627 Series mounted wayside in the track area and calibrated into one common coordinate system. These modules scan the wheel surface and then transmit data to the **Control module** for calculating geometrical parameters of the wheels.

Operation of the scanners is based on the principle of optical triangulation (see Figure 2).

Radiation of a semiconductor laser is formed by a lens in a line and projected to an object. Radiation scattered from the object is collected by the lens and directed to a two-dimensional CMOS image sensor. The image of object outline thus formed is analyzed by a FPGA and signal processor, which calculates the distance to the object (Z-coordinate) for each point of the set along the laser line on the object (X-coordinate). Scanners are characterized by the beginning of the range (SMR) for Z-coordinate, measuring range (MR) for Z-coordinate, measuring range for X-coordinate at the beginning of Z (X_{SMR}) and measuring range for X-coordinate at the end of Z (X_{EMR}).

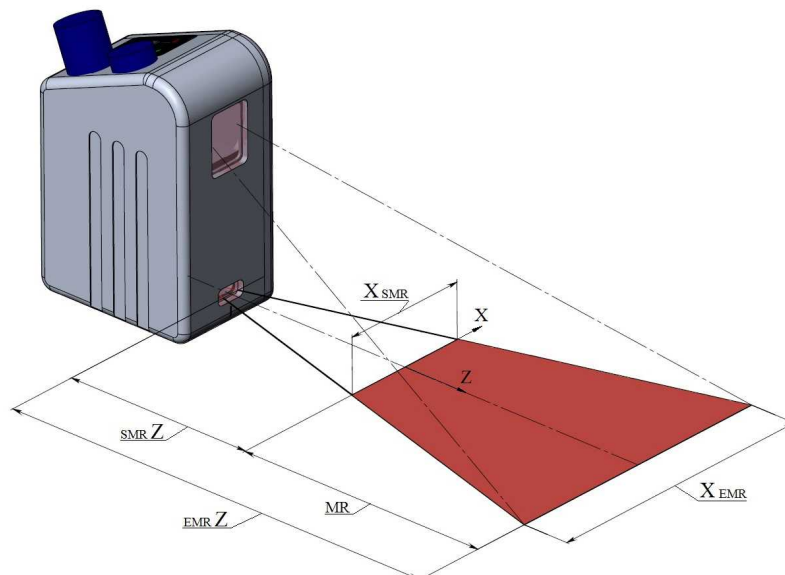
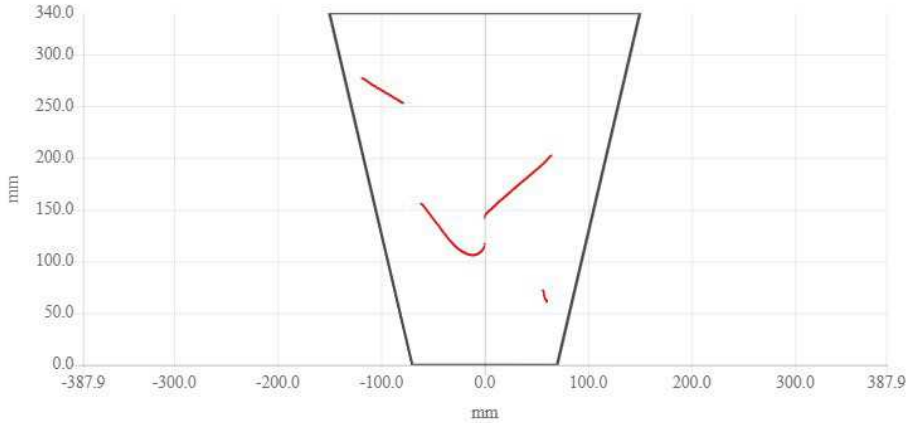

Figure 2

Below are the wheel profiles obtained by scanners when measuring wheelsets. The first profile is obtained by the scanner from the inner side of the rail, the second profile is obtained from the outer side of the rail. The obtained profiles are sent to the **Control module** for further calculations.

Inner side:



Outer side:

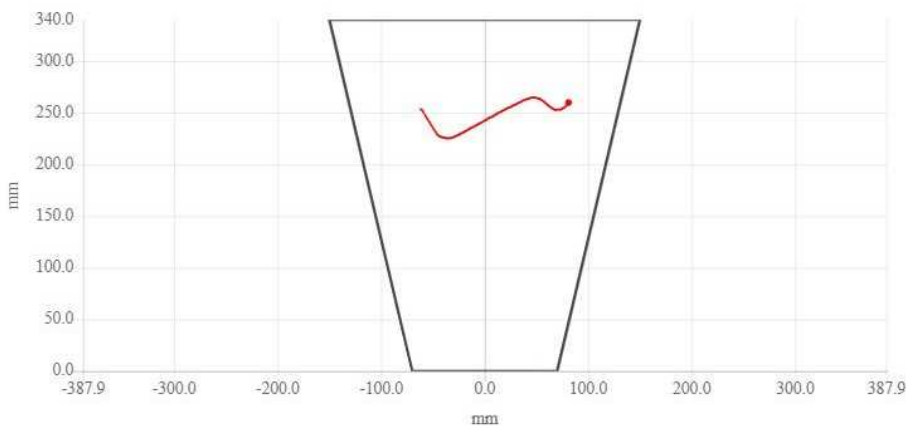

Modules containing two scanners are placed on the outer side of the rail. Modules containing three scanners are placed on the inner side of the rail. In order to avoid mutual influence on each other, scanners located on the opposite sides of the rail have lasers of different wavelengths (RED and IR).

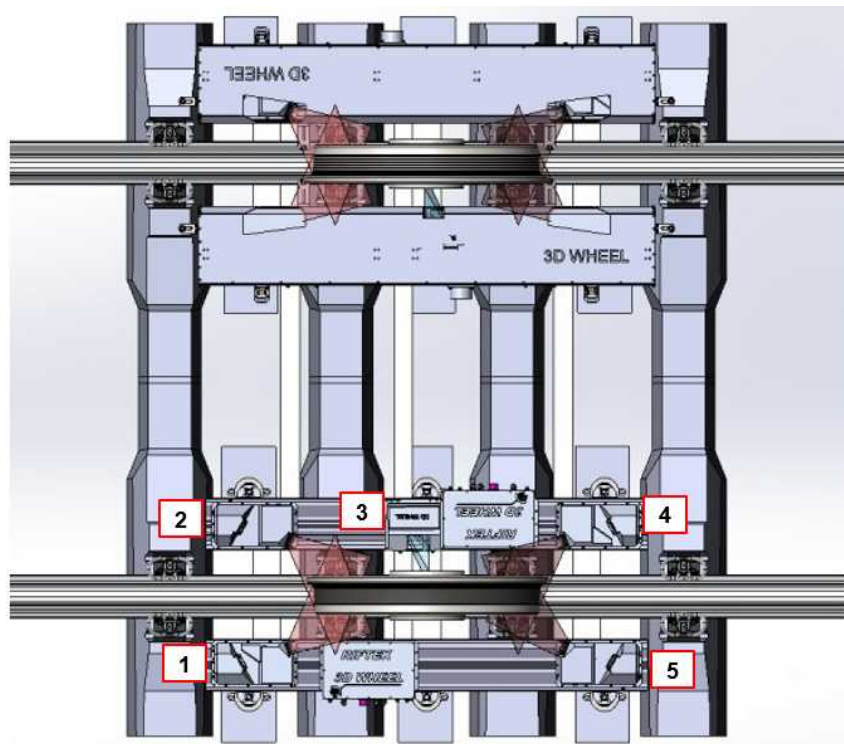

Figure 3

After detecting the wheelset, the laser scanning modules are activated and scan the wheelsets when the rolling stock is passing through the control area. Upon completion of the scanning process, laser scanning modules will be turned off.

Three scanners (#2, #3 and #4 - see Figure 3) are used to measure the wheel diameter.

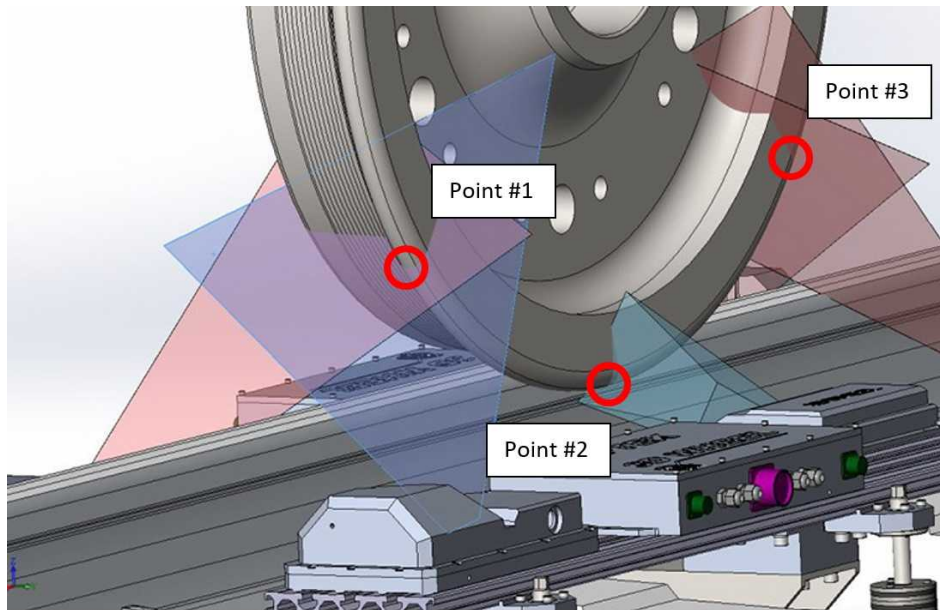

Figure 4

The wheel profile is assembled by two pairs of scanners: #1-2 and #4-5.

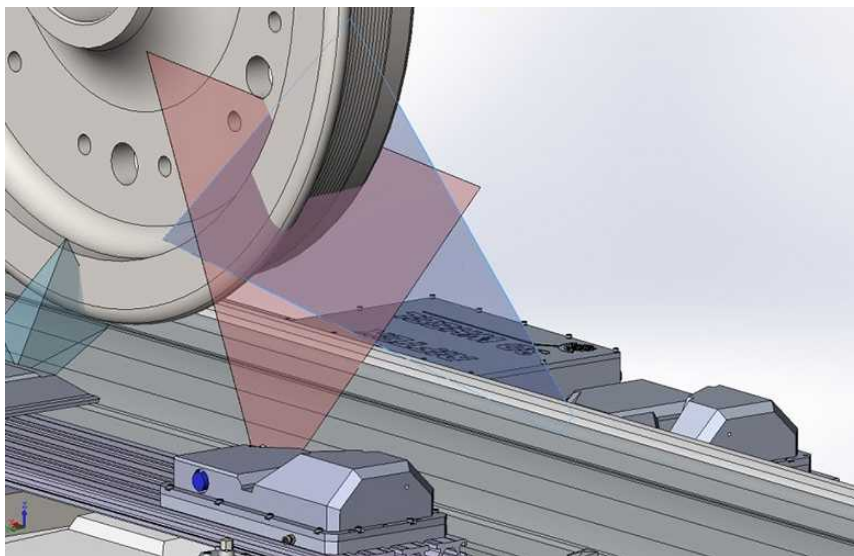

Figure 5

In this case, an undistorted profile is calculated by mathematical transformations, and this undistorted profile is used for further calculations of all necessary parameters of the wheel profile, such as the flange thickness and height, the rim thickness and so on.

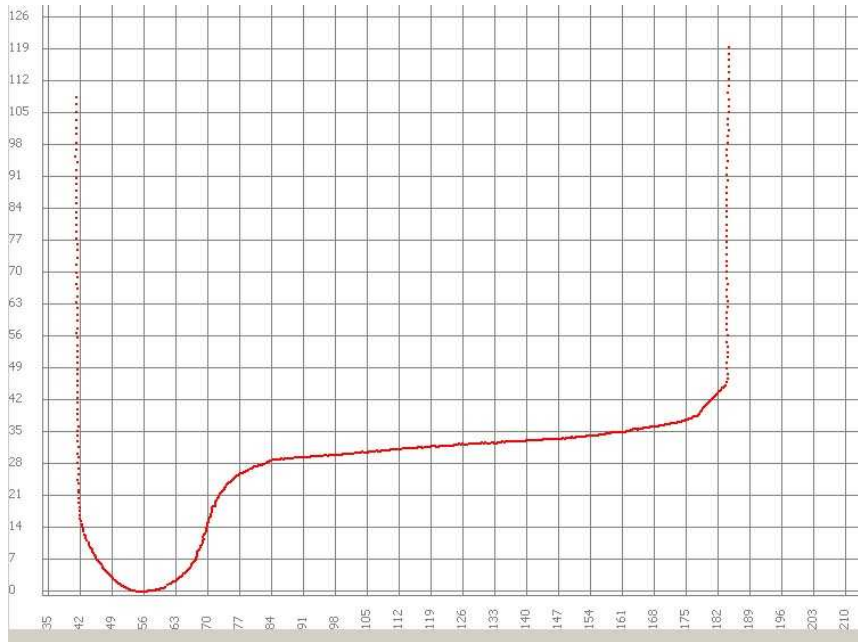

Figure 6

The back-to-back distance is measured at three points on the wheel and averaged. Figure 7 shows three pairs of scanners whose measurements are used for calculations.

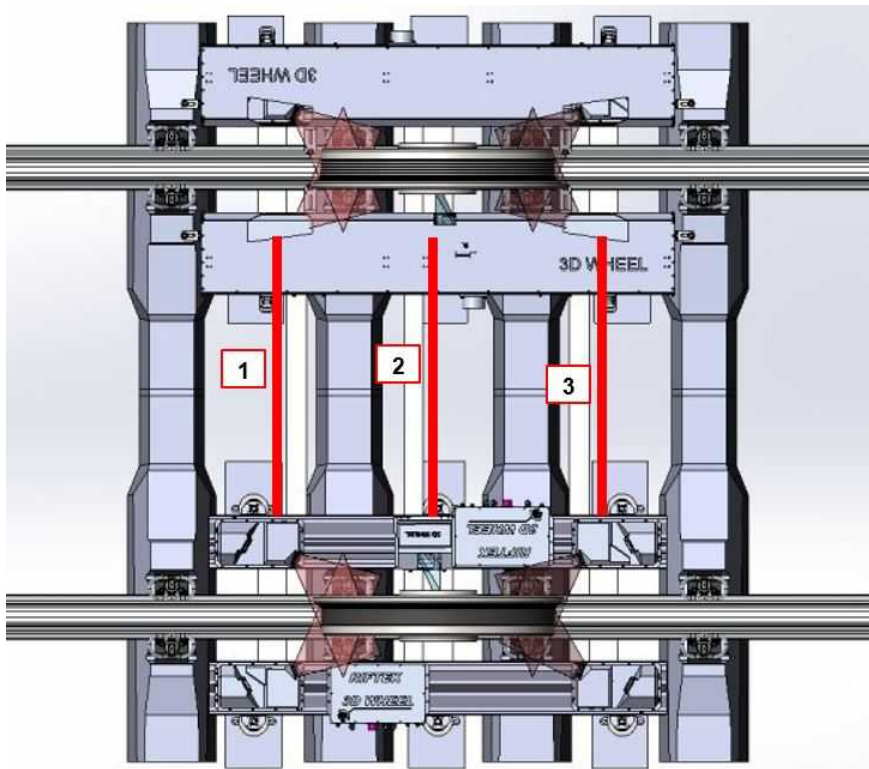

Figure 7

Laser scanning modules come with the special protective housings equipped with the air conditioning system. To eliminate the influence of vibrations and shocks, laser scanning modules are equipped with shock-absorbing supports.

Overall and mounting dimensions of laser scanning modules are shown in Figure 8.

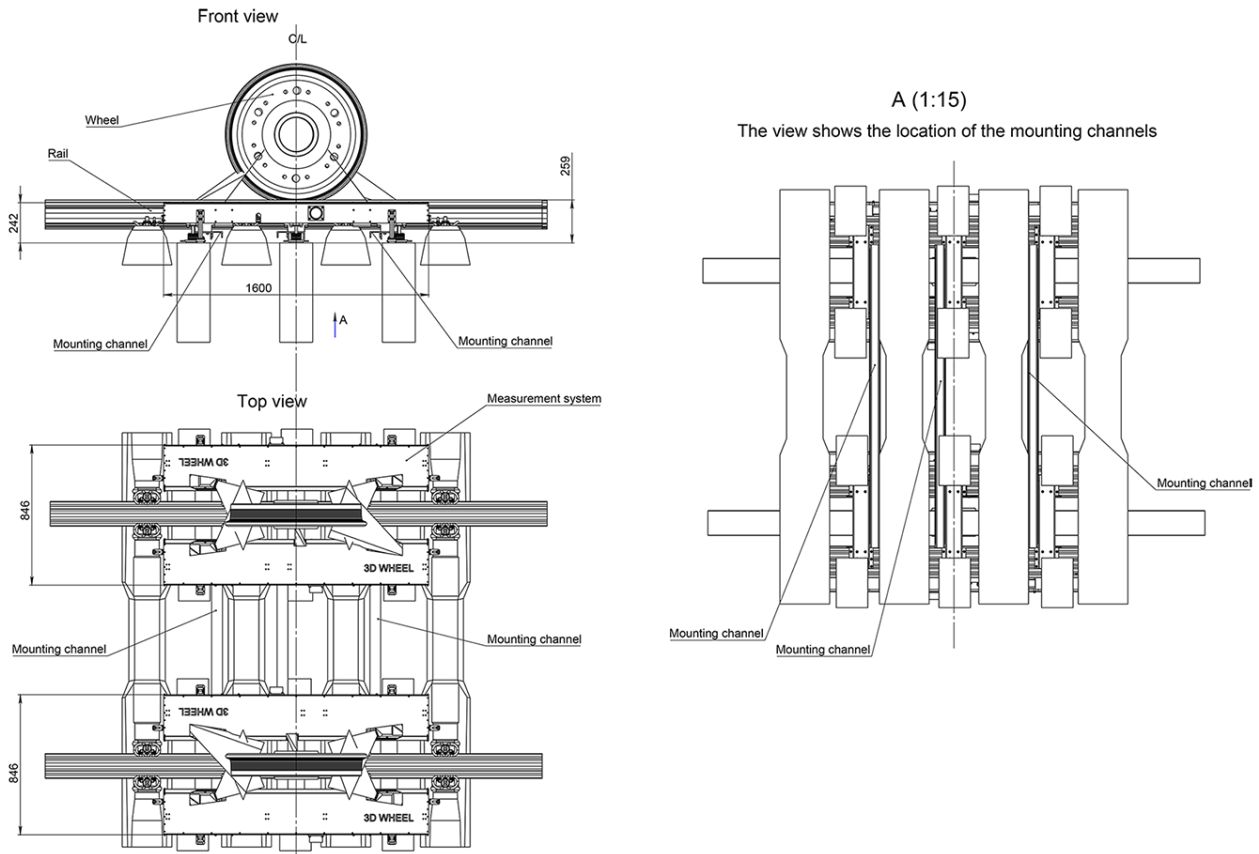

Figure 8

6.2. Air conditioning and protection module

The **Air conditioning and protection module** is designed to maintain a stable temperature inside the laser scanning modules, as well as to protect the laser scanners against mechanical damage.

The heating system is activated when the thermostat inside the protective housing registers a temperature below +15°C. The air is heated by built-in heaters, the warm air circulation is provided by built-in fans. The cooling system is activated when the thermostat inside the protective housing registers a temperature above +24°C.

The mechanical protection system opens the special moving blinds of the protective housings when the rolling stock is detected by the first inductive sensor. Upon completion of the scanning process, the mechanical protection system will close the moving blinds.

6.3. Position monitoring module

The **Position monitoring module** contains three (four for reverse traffic) inductive sensors. Inductive sensors are placed on the railway track as shown schematically in Figure 9.

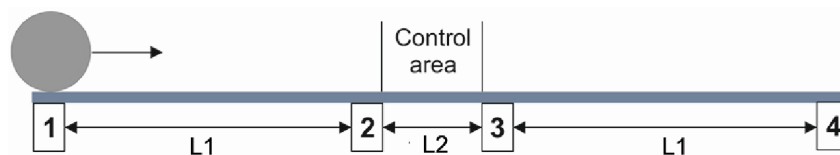

Figure 9

"L1" is the minimum distance between the 1st (or 4th) inductive sensor and the system. It is calculated by the following formula:

$$L1 = \text{max speed (km/h)} * 2 / 3.6$$

max speed (km/h) | L1 (m)

10 | 6

30 | 17

50 | 28

The minimum train speed is calculated by the following formula:

$$\text{SpeedMin} = L1 / \text{measurement timeout}$$

When the wheelset is detected by the first inductive sensor (1), the Control module opens the moving blinds on the protective housings and switches the Laser scanning modules to the data acquisition mode.

When the wheel is detected by the next inductive sensor (2) placed directly in front of the Laser scanning modules, the Control module turns on the lasers of the laser scanners, and the scanning process begins.

When the wheel is detected by the third inductive sensor (3), the Control module turns off the lasers and stops data acquisition.

After measuring the last wheel, the system waits for timeout, and then closes the moving blinds on the protective housings. The system goes into standby mode.

The fourth inductive sensor (4) is used only when the train moves in the opposite direction. In this case, it functions as the first inductive sensor, the third sensor functions as the second, and the second sensor functions as the third.

Figure 10 illustrates the operating principle of inductive sensors:

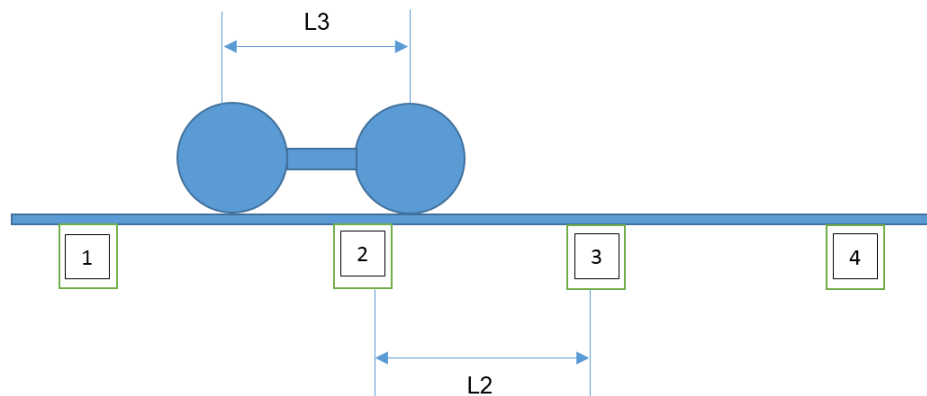

Figure 10

"L2" is a distance between the 2nd and 3rd inductive sensors.

"L3" is the minimum distance between the wheelsets.

IMPORTANT: The minimum distance between the wheelsets must be greater than the distance between the 2nd and 3rd inductive sensors. Otherwise, the first wheelset will not have time to turn off the measurements by passing near sensor #3. This will be done by the second wheelset and the measurement sequence will be disrupted.

6.4. Identification module

The RFID identification module allows to recognize the train number. A particular RFID tag, in which the train number is embedded, will be fitted on the train body. Once the train comes near the system, the RFID readers detect the RFID tags, give a signal to the system and display the train number as described in par. [9.4.2.1](#). After the train has been identified, the number of wheelsets of that particular identified train will be counted by inductive sensors installed nearby the system. The number of wheelsets will be displayed next to the train number as described in par. [9.4.2.1](#).

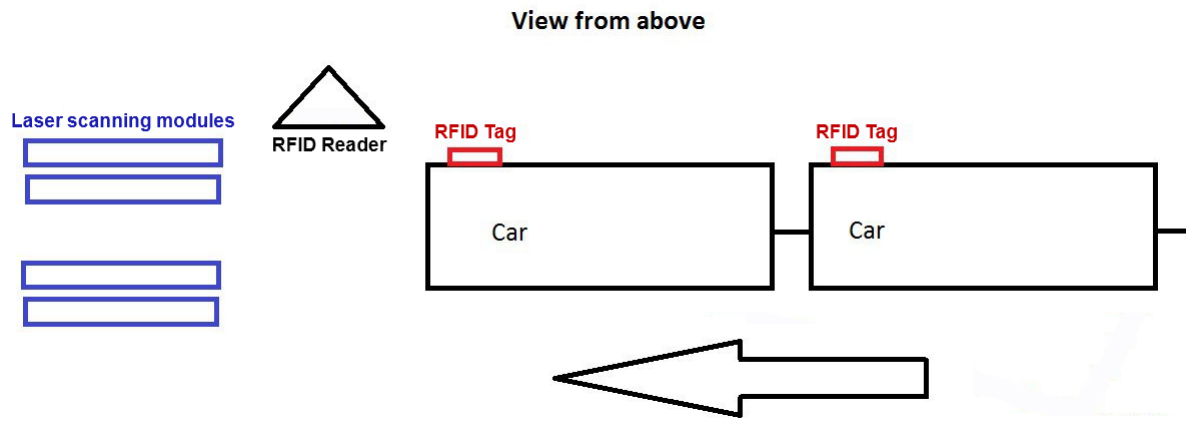

Figure 11

6.5. Control, communication and power module

The **Control module** is a server computer. It is intended to coordinate the operation of all other modules, to gather data from laser scanners, to create a mathematical model of the wheel profile, and to calculate geometrical parameters.

The **Communication module** is intended to organize a remote access to the 3DWheel system for testing, configuring parameters, and for transmitting data.

The **Communication module** contains:

- Network switch.
- Wi-Fi modem.
- 3G modem.

The **Power module** is intended to maintain a stable power supply for the 3DWheel system. It provides 60 minutes of uninterrupted power supply when the mains voltage is lost.

The **Power module** contains:

- Uninterruptible power supply (UPS).
- Power supply unit (2 pcs.): for laser scanning modules and for the heating system.

These three modules are located in the control cabinet, the appearance of which is shown in Figure 12.



Figure 12

7. Geometric parameters of the wheel under control

Geometric parameters of the wheelset are calculated automatically after laser scanning of wheels is completed. To calculate geometric parameters of the profile, use is made of reference points on the wheel profile. Location of the reference points is defined by L- and P-parameters.

7.1. Measurement constraints

7.1.1. Longitude shift

Longitude shift is a shift along the rails. This shift is not limited, only the maximum speed of the train is limited. If the speed of the train exceeds the maximum permissible speed, the wheels will not be measured.

7.1.2. Lateral shift

Lateral shift is a shift across the rails. The maximum shift across the rails is 20 mm from the center position of the wheelset.

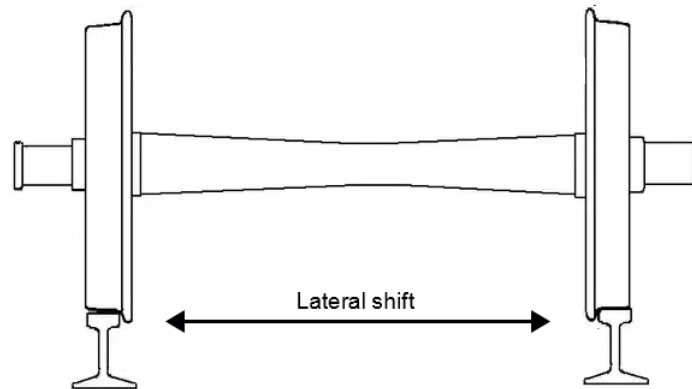

7.1.3. Misalignment, X axis

Misalignment, X axis (axis along the rails) – the maximum angle of rotation of the wheel along the rail (0.12 radians).

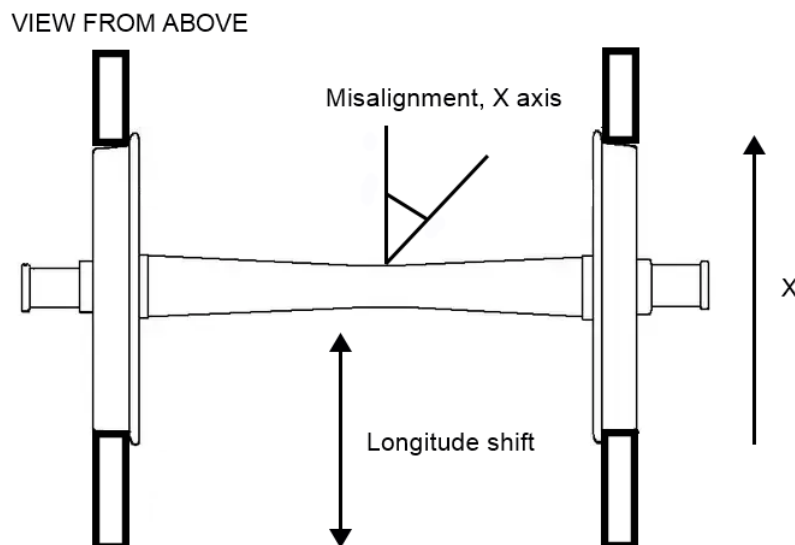

7.1.4. Misalignment, Z axis

Misalignment, Z axis (vertical axis) – the maximum angle of inclination of the wheel relative to the vertical axis (0.06 radians).

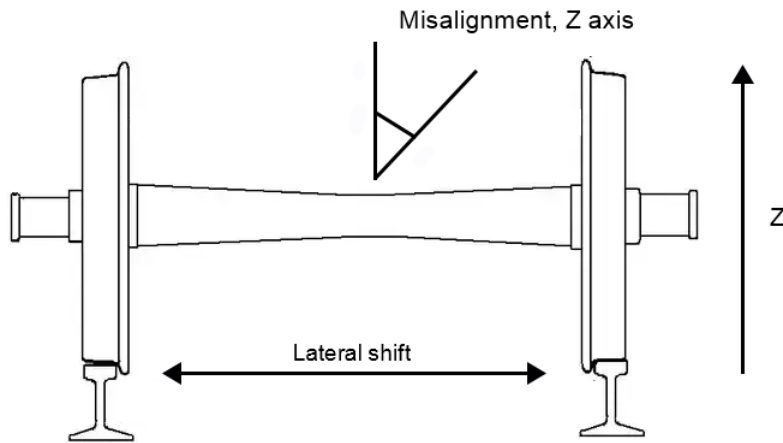

7.2. Measured parameters

7.2.1. Flange height, sH

Calculation of the flange height is determined by parameter L2.

The flange height is calculated as a distance measured vertically between the flange top and the point of wheel rolling surface at any preselected distance (L2) away from the inner face of the wheel tire.

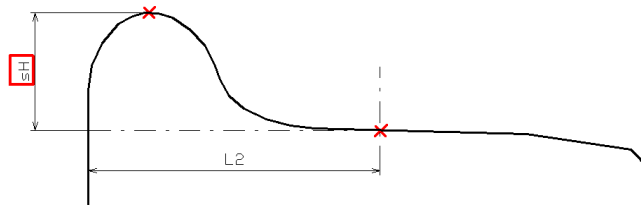

7.2.2. Flange thickness, sD

Calculation of the flange thickness is determined by parameter L3 that specifies Point 1 on the flange surface. There are two ways to specify the parameter:

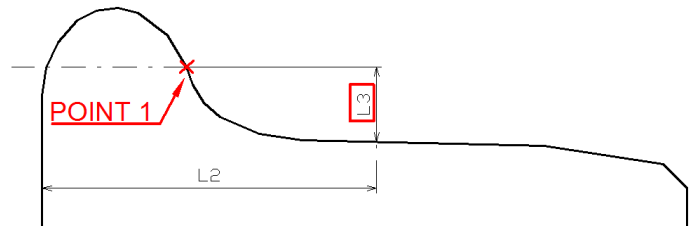
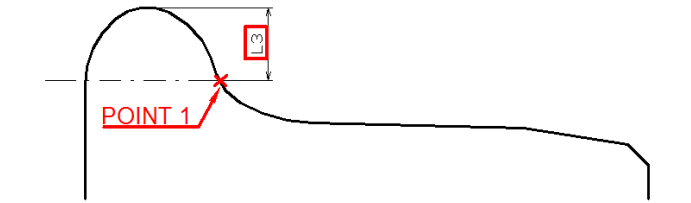
<p>Method 1</p> <p>Height L3 is measured vertically upward from a point of the wheel rolling surface, the position of which is defined by parameter L2.</p>	 <p>The diagram shows a cross-section of a wheel flange. A horizontal dashed line represents the rolling surface. A vertical dimension line labeled 'L3' measures the height from this surface to 'POINT 1' on the flange top. A horizontal dimension line labeled 'L2' indicates the distance from the inner face of the wheel tire to 'POINT 1'.</p>
<p>Method 2</p> <p>Height L3 is measured vertically downward from the flange top.</p>	 <p>The diagram shows a cross-section of a wheel flange. A vertical dimension line labeled 'L3' measures the height from the top of the flange down to 'POINT 1' on the flange top. A horizontal dimension line labeled 'L2' indicates the distance from the inner face of the wheel tire to 'POINT 1'.</p>

The flange thickness is calculated as a distance measured horizontally at any preselected height (L3) between two points (Point 1 and Point 2) lying on the opposite sides of the flange top.

There are two ways to calculate the flange thickness:

Method 1	
Point 1 is defined by parameter L3. Point 2 is the intersection point of a horizontal line and a line lying on the internal face of the wheel.	
Method 2	
Point 1 is defined by parameter L3. Point 2 is the intersection point of a horizontal line and the flange surface.	

Note: Both calculation methods can be performed simultaneously.

7.2.3. Flange slope, qR

Calculation of the flange slope is determined by parameters L1 and L3 (or L4).

<p>Height L1 is measured vertically downward from the flange top and determines Point 3 on the flange surface.</p> <p>Height L4 is measured vertically upward from a point of the wheel rolling surface, the position of which is defined by parameter L2 (wheel rolling circle), and determines Point 4 on the flange surface.</p>	
---	--

There are three ways to calculate the flange slope:

Method 1 Calculation in millimeters	
The flange slope is calculated as a distance measured horizontally between Point 3 and Point 1 (or 4).	
Method 2 Calculation in degrees	
The slope is calculated as the inclination angle of a straight line passing through Point 1 or 4.	
Method 3 Pass/Fail	
The calculation is performed according to Method 1. The software displays information only about whether the measured slope meets the tolerance conditions or not.	

7.2.4. Root wear, sWr

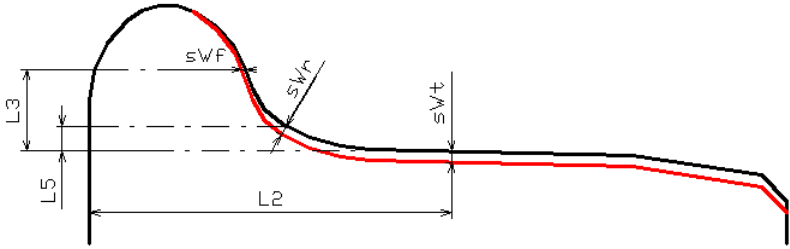
Root wear	sWr	is calculated as a distance along the normal to the tangent at the point at height L5 from the wheel rolling circle of the measured profile and the selected reference.
 <p>* Red color indicates the worn profile</p>		

7.2.5. Wheel tread hollow, HI

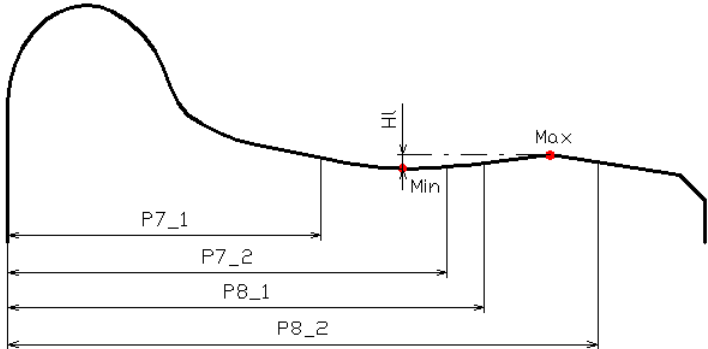
Wheel tread hollow	HI	is calculated as a difference between the maximum and minimum values within the specified limits. The search limits: - parameters of the minimum value [P7_1..P7_2]; - parameters of the maximum value [P8_1..P8_2].
		

7.2.6. Wheel rim thickness, sT

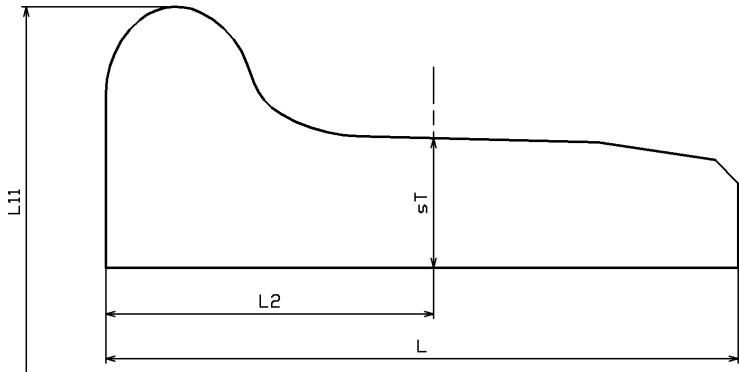
Wheel rim thickness	sT	is calculated as a distance measured vertically between the internal rim diameter and a point on the wheel rolling circle located on any preset distance L2 away from the wheel face. L11 is an external wheel diameter.
		

7.2.7. Flange rollover, Rf

The flange rollover is a protrusion resulting from the deformation of the surface layers of the flange metal toward its apex.

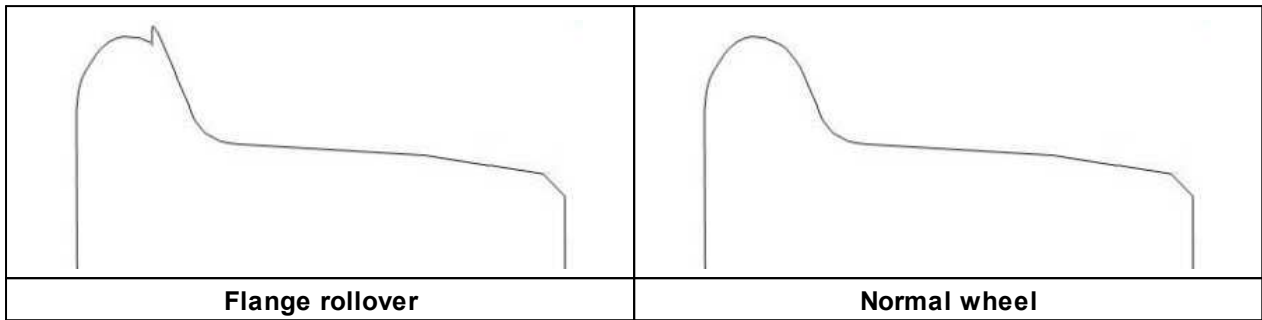

7.2.8. Tread rollover, Rt

The displacement of the metal from the rolling surface to the chamfer and then to the outer edge of the rim. The distance from the outer edge of the rim to the most protruding part.

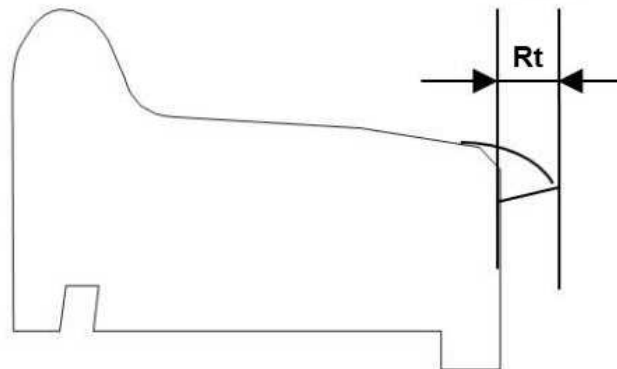

7.2.9. Wheel diameter, D

Wheel diameter	D	is calculated by the formula: D = 2*T + L10 T – rim thickness; L10 – diameter of wheel center
----------------	---	--

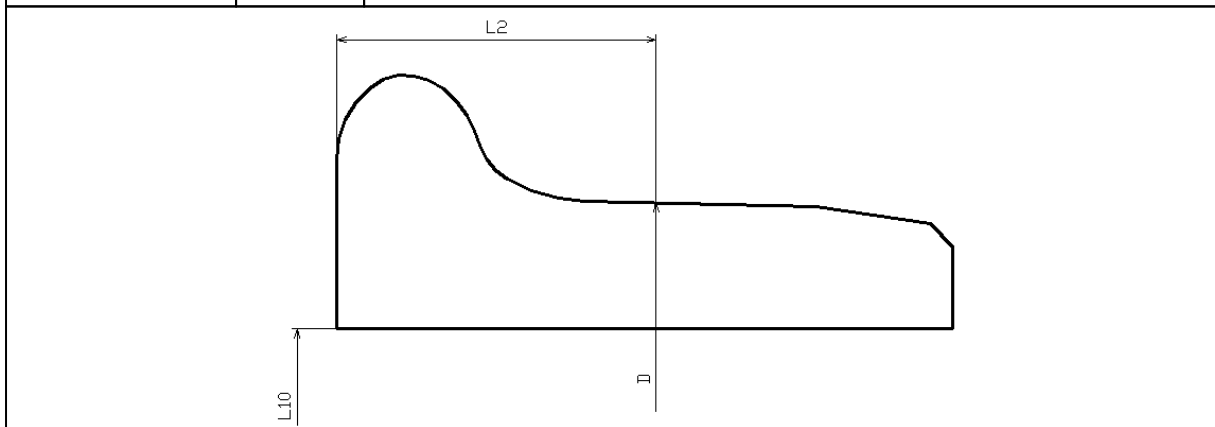

7.2.10. Wheel width, L

Wheel width	L	is calculated as the distance measured vertically between the inner and outer surfaces of the wheel.
-------------	---	--

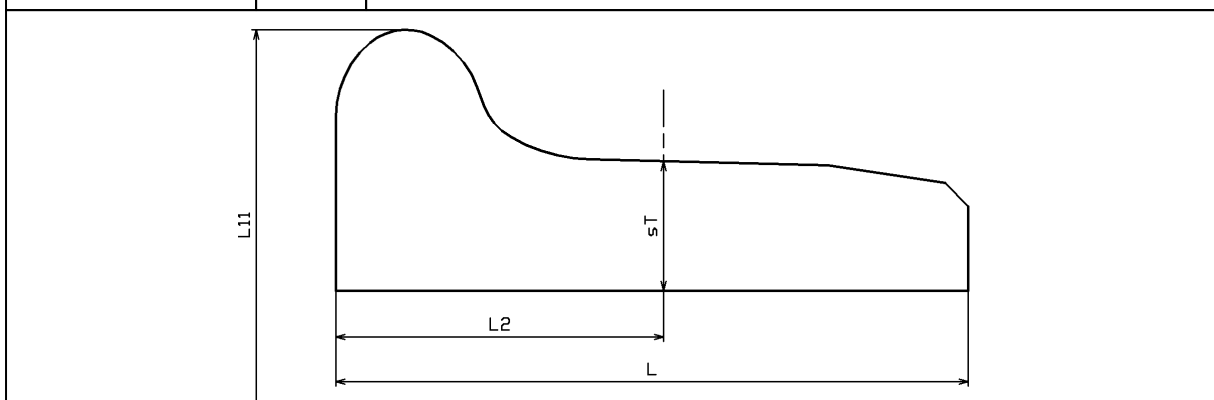

7.2.11. Back-to-back distance, B2B

The back-to-back distance is a distance between the inner surfaces of the wheels in a wheelset.

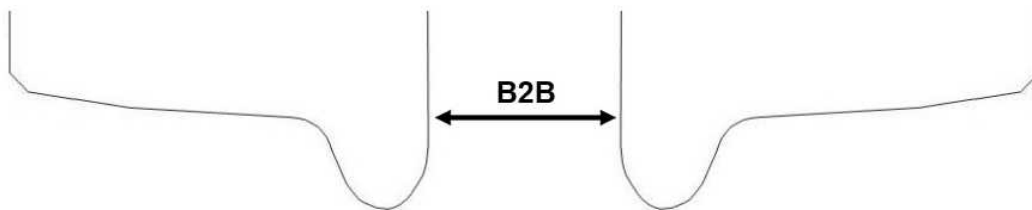

7.2.12. Wheel chamfer, Wc

The wheel chamfer is measured by the inclination angle and length.

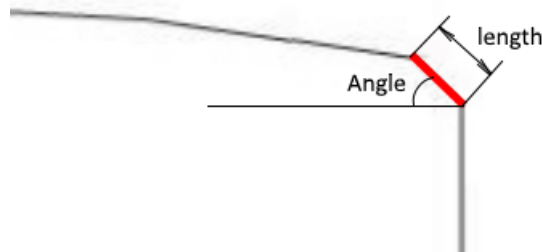

7.2.13. Tread taper, Tt

The tread taper is measured as the inclination angle of the tread surface between the tread point (63.5 mm from the inner face of the wheelset) and the wheel chamfer.

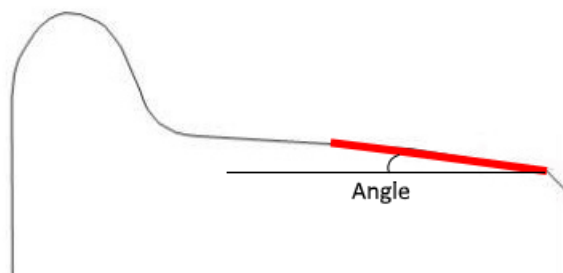

8. Intended use

In order to use the system properly, it is necessary to read this User's Manual and to follow all instructions.

The specialists, which will work with the system, must have the appropriate qualifications, and must receive the training conducted by the Manufacturer. The specialists must know about all system components, risks associated with the system installation, permissible actions and how to handle emergency situations.

All repair works must be performed in consultation with the Manufacturer in order to avoid critical damage to the equipment.

8.1. Preparation for use

The preparation involves the following steps:

- Visual inspection.
- System installation.
- Switching on the system.
- Calibration.

8.1.1. Visual inspection

- Check the equipment for completeness and absence of damage.
- Check the cables and ground wires.
- Check the windows of laser scanners and, if necessary, clean them with a soft, lint-free cloth and non-streaking glass cleaner or 20% alcohol.

8.1.2. System installation

8.1.2.1. Mounting place

The 3DWheel system must be installed in accordance with the documentation and in consultation with the Manufacturer.

The mounting place must be prepared for the system installation - all preparation work must be performed under control of the Manufacturer's specialists.

Make sure that the mounting place meets the following conditions:

- The railway track, where the system will be installed, must not have the angle of inclination greater than 5°.
- There must be enough space to install the inductive sensors onto the lower face of the rail.

8.1.2.2. Equipment installation

The system is supplied as a set of modules ready to install. The specialists responsible for the system installation must have the appropriate qualifications.

Safety precautions:

- Lift and move the equipment carefully, without sudden movements. The modules weighing more than 10 kg must be transported using the special equipment (trolley or forklift).
- The equipment for transporting the modules must be certified, and its maximum workload must be greater than the cargo weight.
- Only people working on the system installation are allowed to be in the installation area.

ATTENTION!

- The system must be grounded – static electricity may cause the failure of electronic components.
- All power cables must be shielded.

8.1.3. Switching on the system

Supply power to the system – 380 V AC.

8.1.4. Calibration

ATTENTION!

During the first two months after commissioning, the calibration procedure must be performed once a week. Further, the system must be calibrated once a month.

The calibration procedure is carried out using the special calibration bogie supplied with the system.

To perform the calibration procedure, follow the steps below:

- 1) Connect a laptop to Wi-Fi of the 3DWheel system.
- 2) Run the **3DWheel** program.
- 3) In the **3DWheel** program, click the **Open Shields** button to open the protective shields:

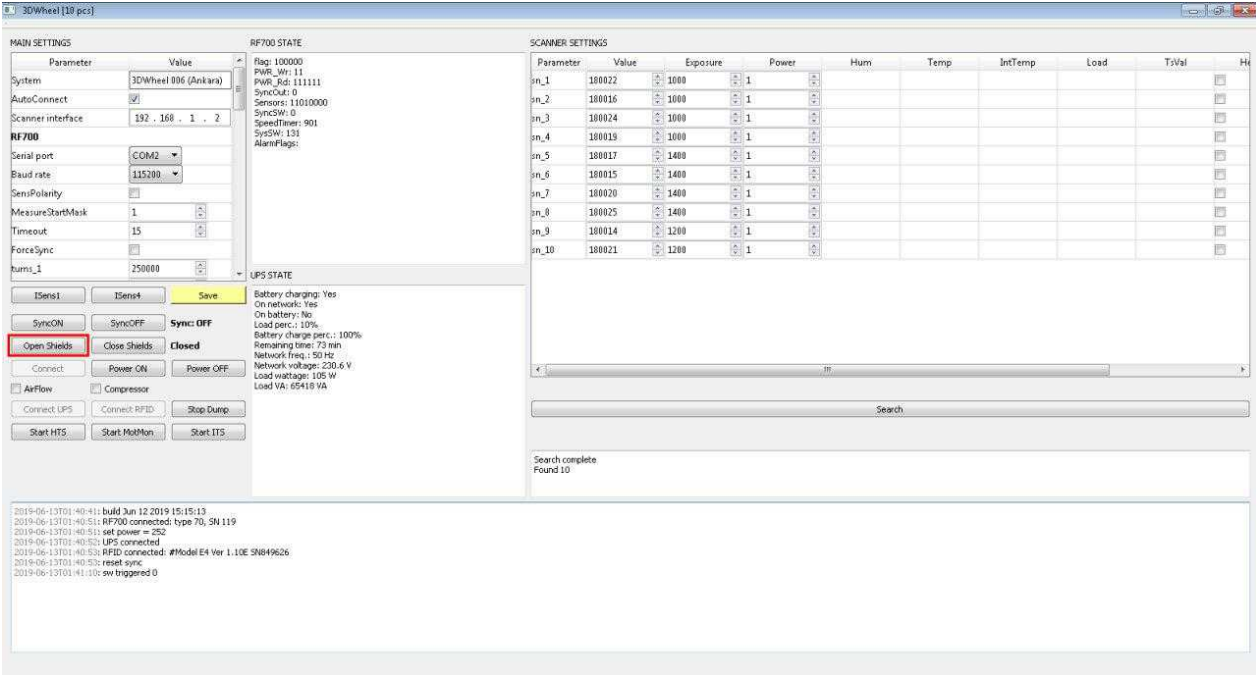

4) In the **3DWheel** program, click the **Power ON** button to turn on the lasers.

5) Install the calibration bogie:



- 6) Run the **3DWheel Calibration** program.
- 7) Go to the **Parameters** tab and tick the following check boxes: Sensor #1, Sensor #2, Sensor #4, Sensor #5.

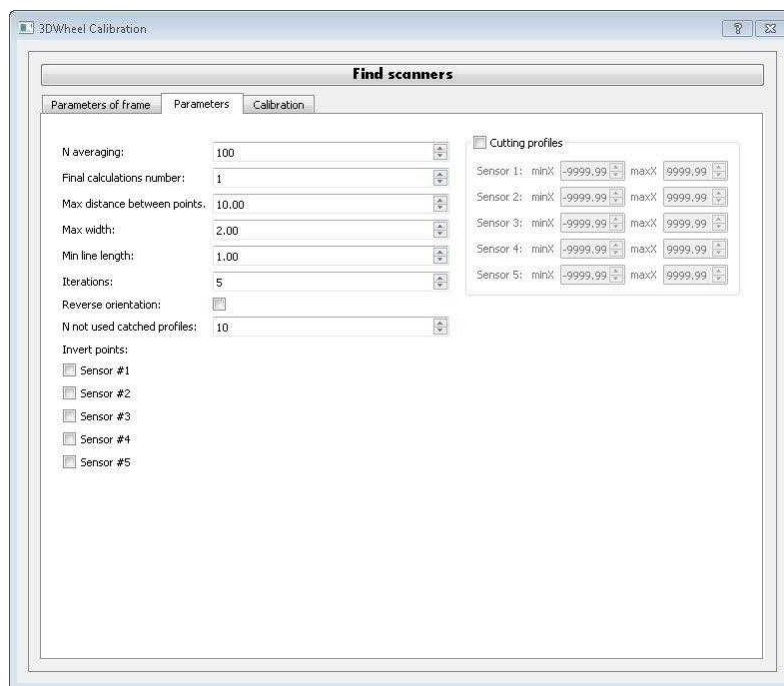

- 8) Go to the **Calibration** tab:

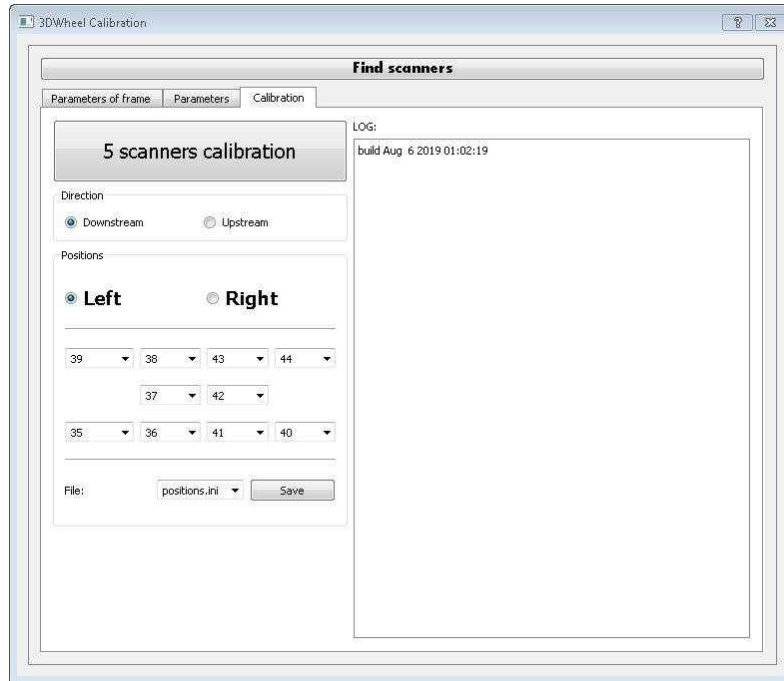

- Select **Direction**: Downstream or Upstream.

NOTE: Five of the scanners are calibrated together (scanners of the left or right laser scanning module).

The calibration can be done using both halves of the calibration bogie. If you calibrate the scanners of the *right* scanning module using the *right* half of the calibration bogie, you need to select **Downstream**. If, for example, you calibrate the scanners of the *right* scanning module using the *left* half of the calibration bogie, select **Upstream**.

- Select a position: Left or Right.
- Click the **5 scanners calibration** button.

9) In the appeared window, go to the **Left side** tab or the **Right side** tab, depending on the side that you calibrate:

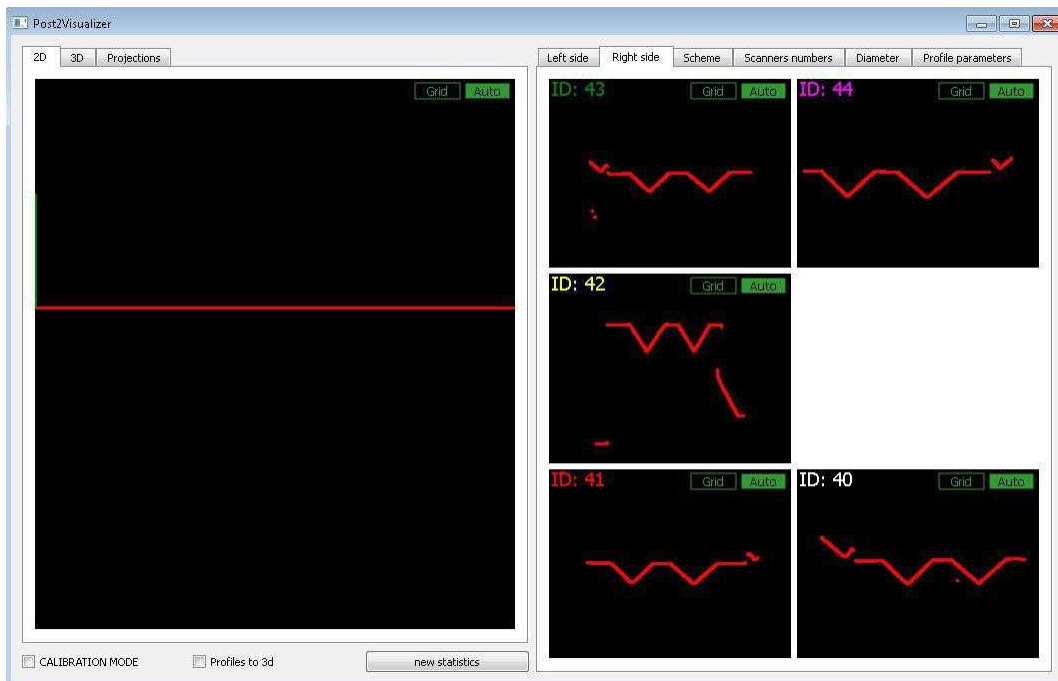

All scanners must see the full profile of the calibration plate. If any scanner sees an incomplete profile or a profile with gaps, move the calibration bogie until a profile is good.

- 10) To start the calibration process, tick **CALIBRATION MODE** in the lower left corner of the window. When the calibration process is complete, you will see "100 cbrs" under the scanner ID.



- 11) Restart the **3DWheel Calibration** program.
 12) Repeat the steps 7-11 to perform the calibration procedure for other scanners.
 13) In the **3DWheel** program, click the **Power OFF** button to turn off the lasers.
 14) In the **3DWheel** program, click the **Close Shields** button to close the protective shields.
 15) Make sure that all parameters remain unchanged.

8.2. Operating the system

When all preparation work is done and the system is powered on, it is completely ready to operate.

The measurement process starts automatically when an inductive sensor detects the wheel. Wheel profiles are taken when the rolling stock goes through the control area. The maximum train speed is 120 km/hour.

Data collected from all scanners is transmitted to a server computer via Ethernet to calculate the geometric parameters. The calculated parameters are sent to the database and to the client application.

9. Railway administration software

9.1. System requirements

Operating system	<ul style="list-style-type: none"> Windows 7 and later, or Linux
Memory	at least 16 GB RAM
SSD	at least 200 MB available
Display resolution	Full HD minimum
Software	OpenGL 2.0.

9.2. Starting up

To start the Railway Administration Software, you need to run **ras.exe**.

9.3. Database connection

After you run **ras.exe**, the following window appears:



To connect to the database, enter the following data: database server address, database schema name, database username, and database password. The data mentioned above is provided by the manufacturer.

9.4. Main window

9.4.1. "BASIC WIZARDS" tab

The **BASIC WIZARDS** tab contains preset program settings. If necessary, the user can change them.

9.4.1.1. Users

The **Users** tab:

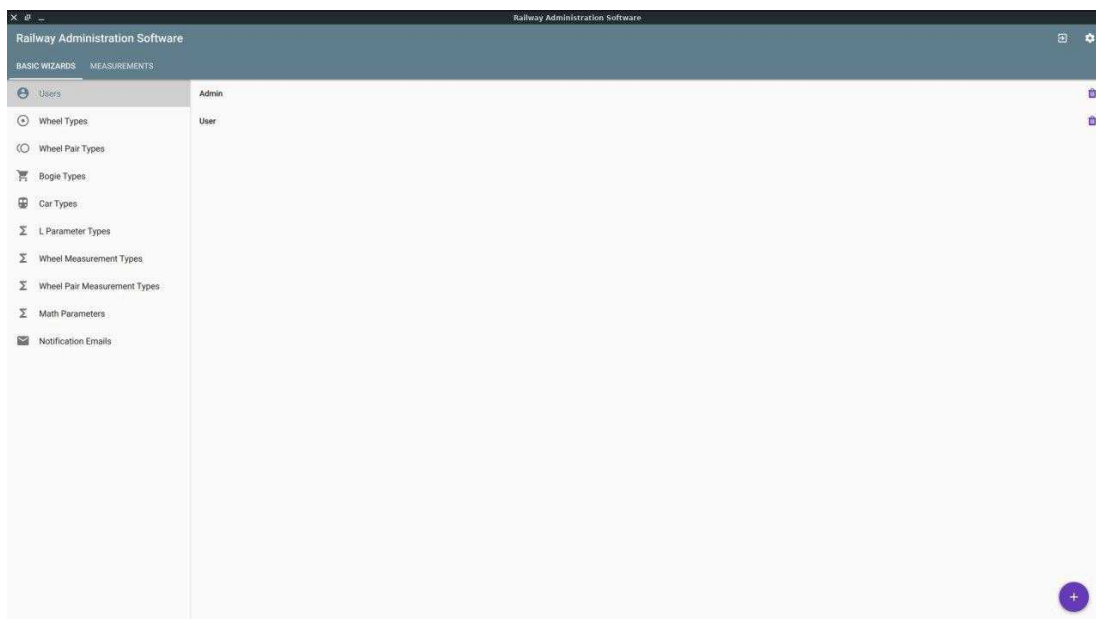

The **Users** tab is intended to manage the user accounts.

To create a new account, click the button in the lower right corner - . The **Create user** window appears:

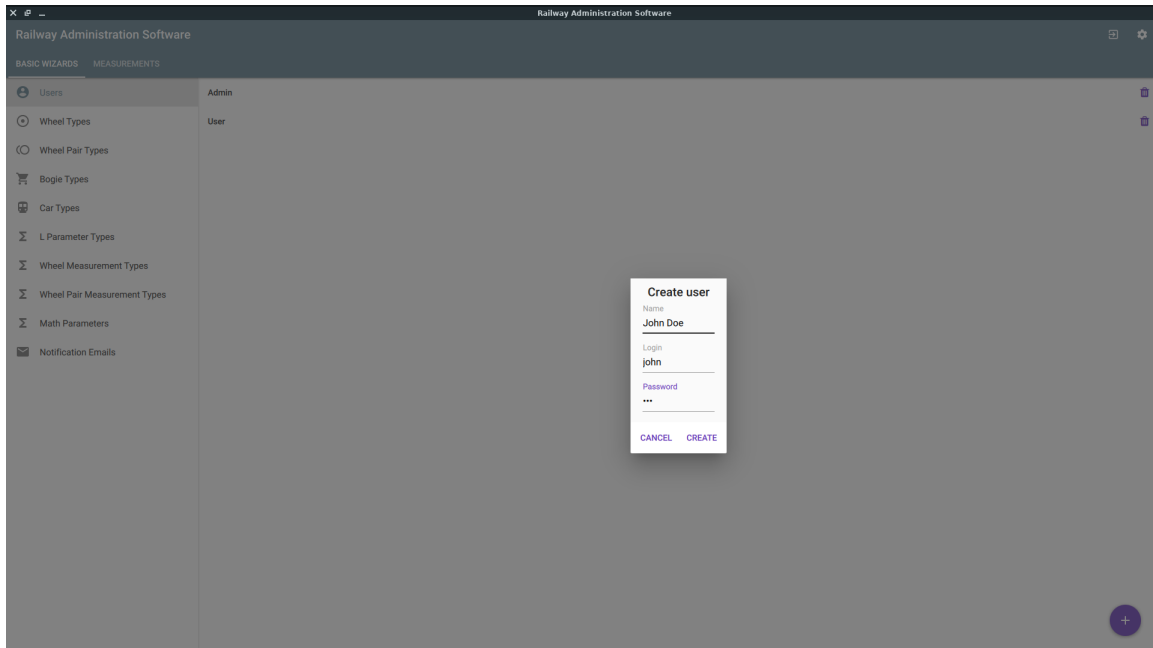

Populate the fields and click **CREATE**.

To edit the user account, click on it in the list. The **Edit user** window appears:

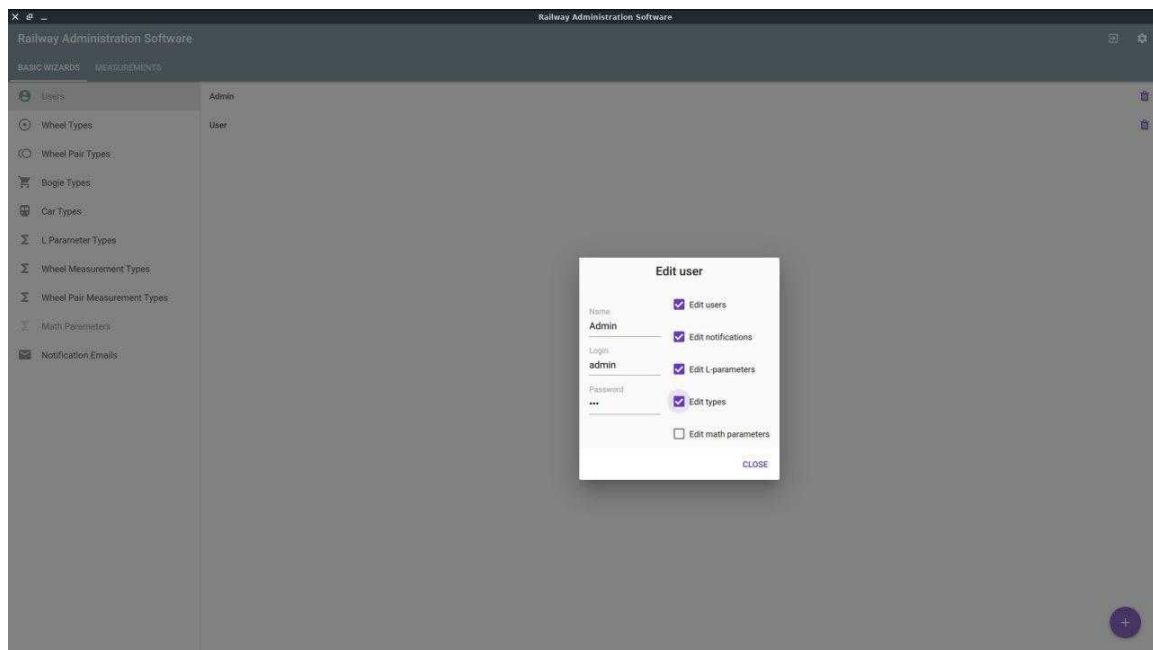

In this window, you can change the name, login, password, and permissions.

To delete the user account, click .

9.4.1.2. Wheel Types

The **Wheel Types** tab:

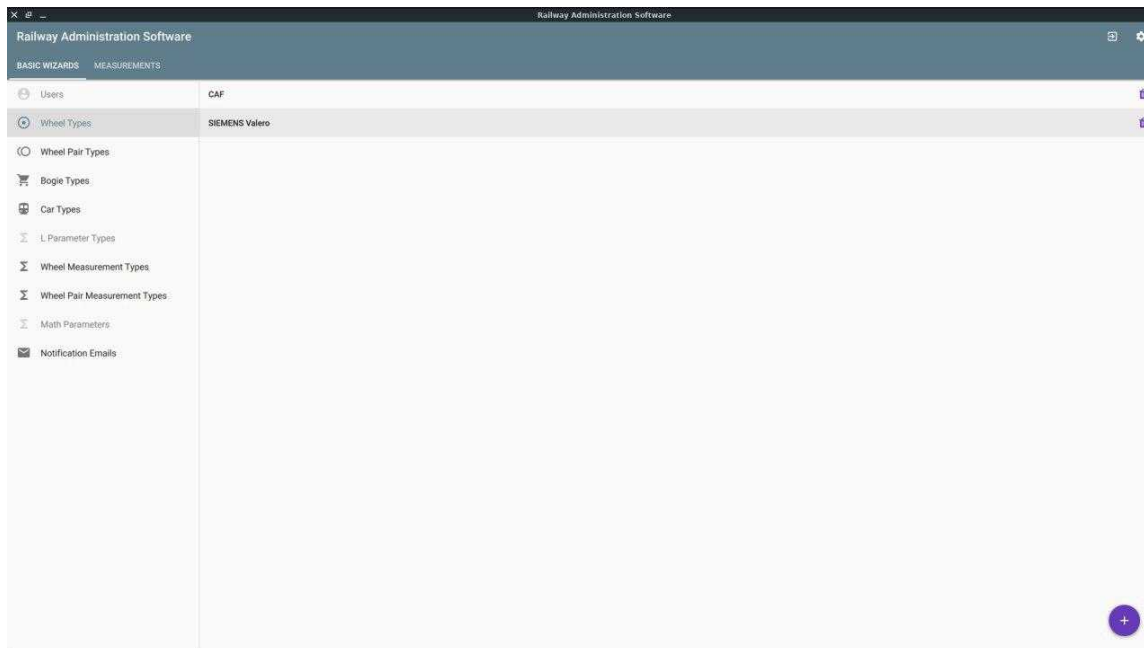

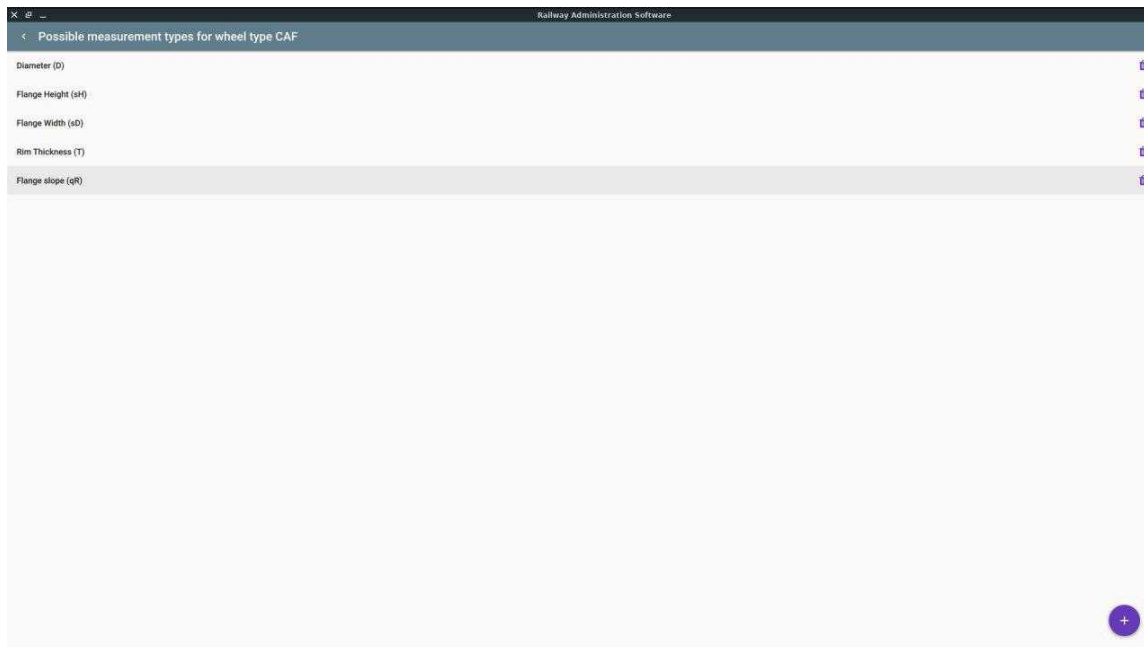

The **Wheel Types** tab contains a list of preset wheel types. Each wheel type contains a list of measurement types with preset nominal values and tolerances.

To view or edit a list of measurement types, click on the name of the wheel type. You will see:

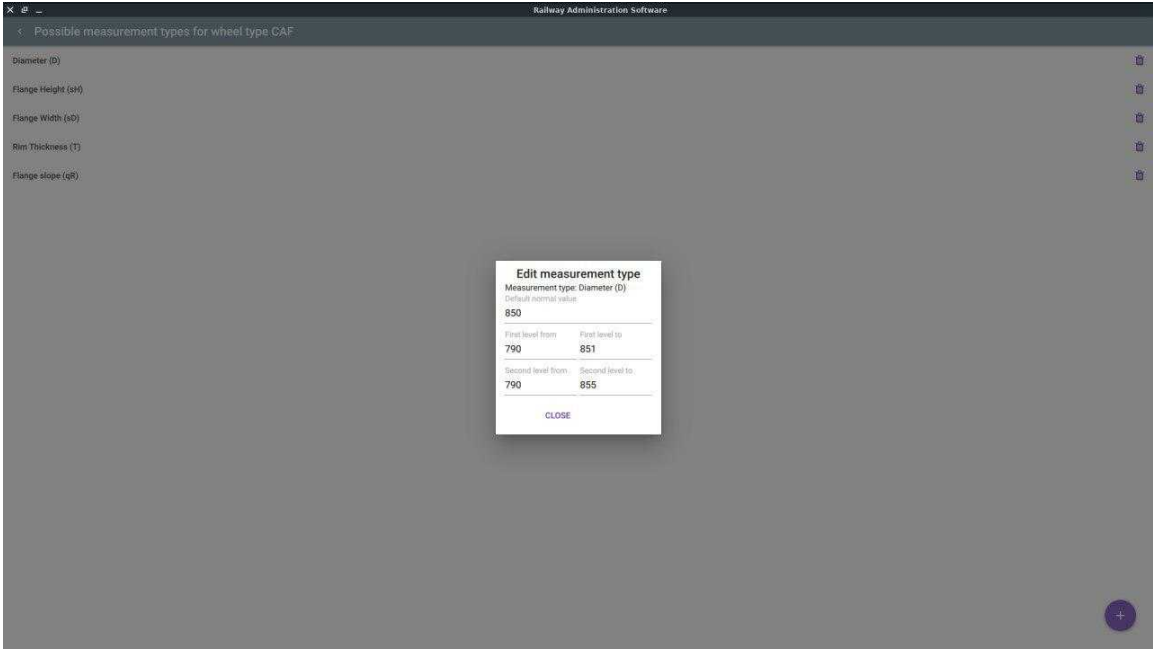

To view or edit the nominal values and tolerances, click on the measurement type. The following window appears:



Change the values and click the **CLOSE** button, or press the **Esc** key.
 To go back to the **Wheel Types** tab, click the button in the upper left corner - .

To add a new wheel type, click the button in the lower right corner of the **Wheel Types** tab - . The following window appears:

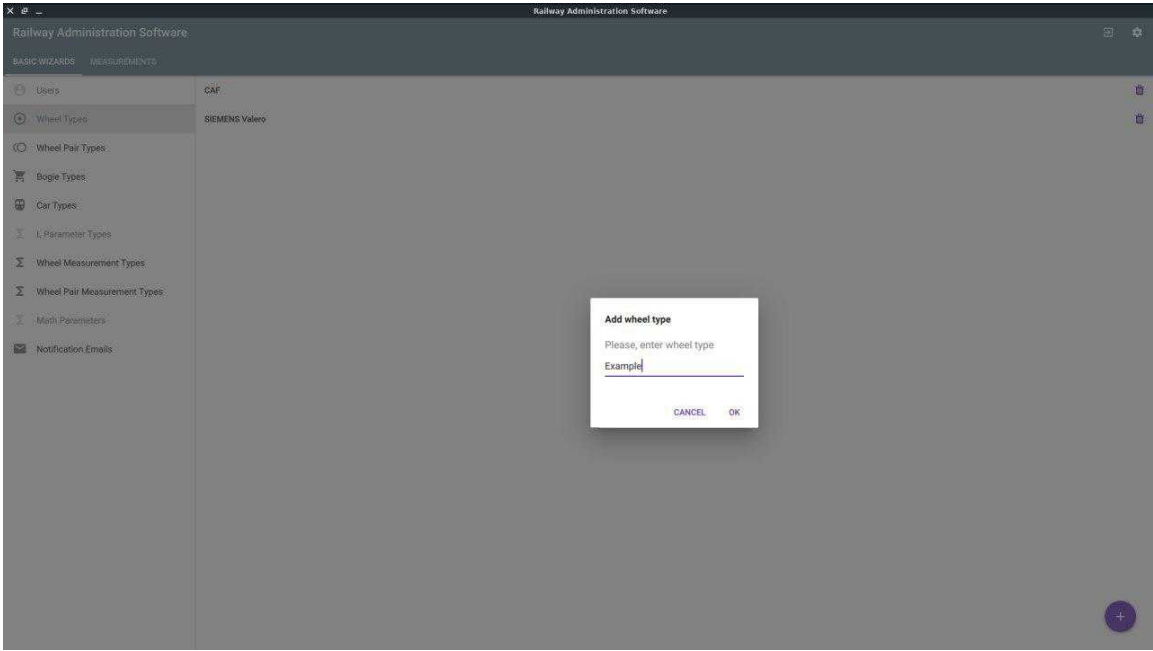

Enter the name of a new wheel type and click **OK**. A new wheel type will be added to the list.

To add the measurement types for the new wheel type, click on its name in the list, and then click .

To delete the wheel type or the measurement type, click .

9.4.1.3. Wheel Pair Types

The **Wheel Pair Types** tab:

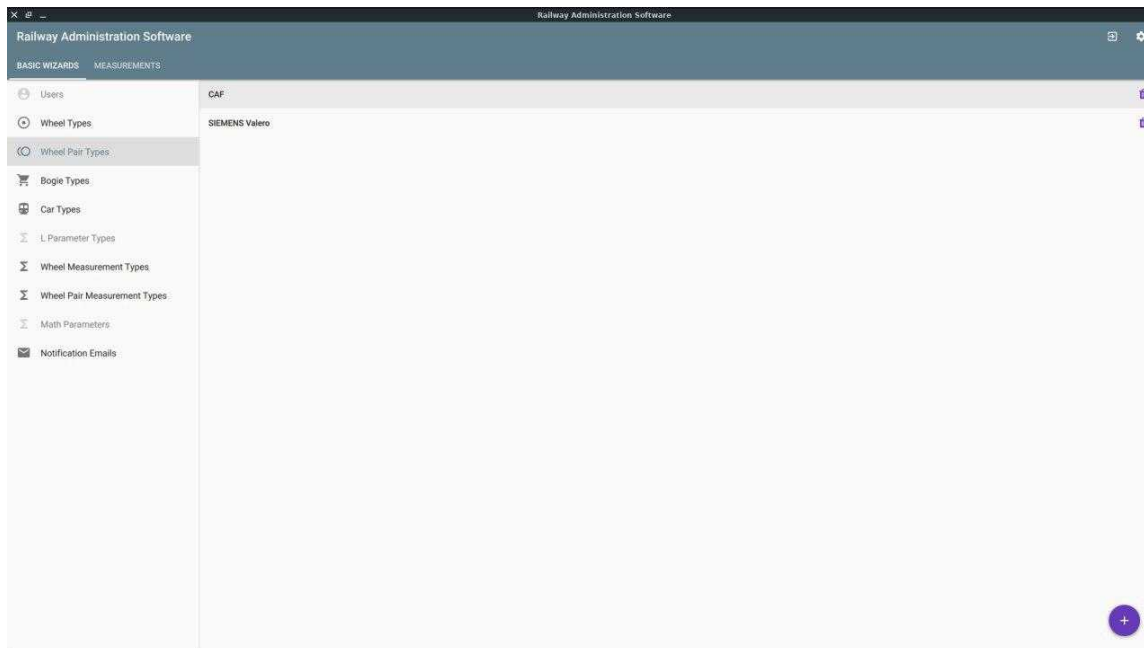

30

The **Wheel Pair Types** tab contains a list of preset wheelset types. Each wheelset type contains a list of measurement types with preset nominal values and tolerances.

To view or edit a list of measurement types, click on the name of the wheelset type. You will see:

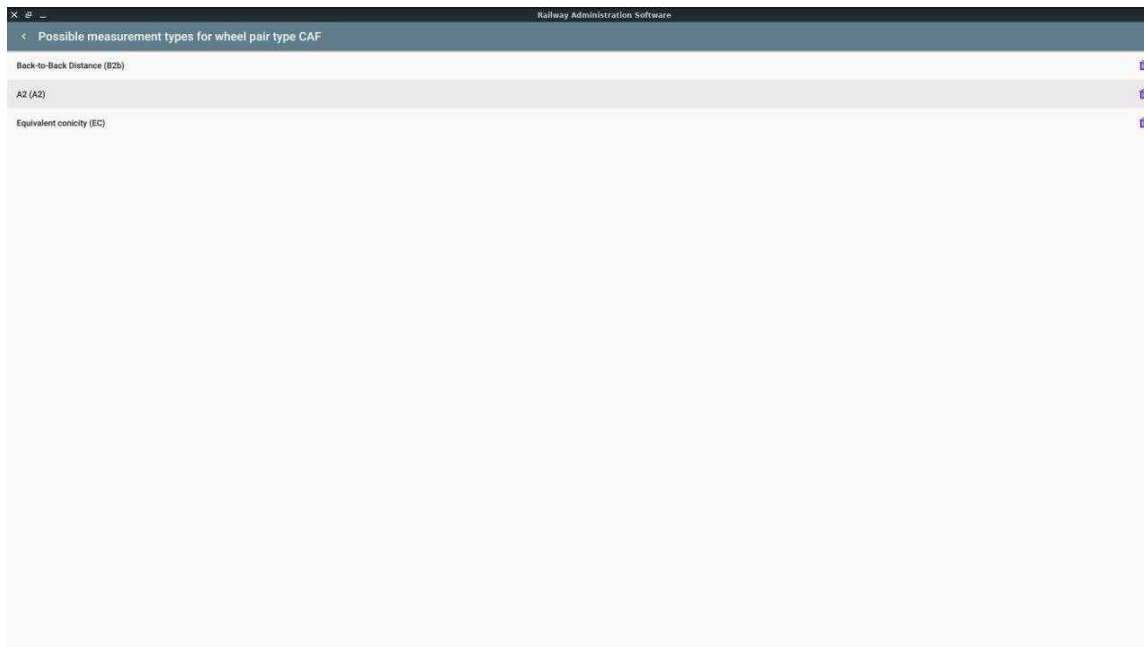

To edit the nominal values and tolerances, click on the measurement type. The following window appears:

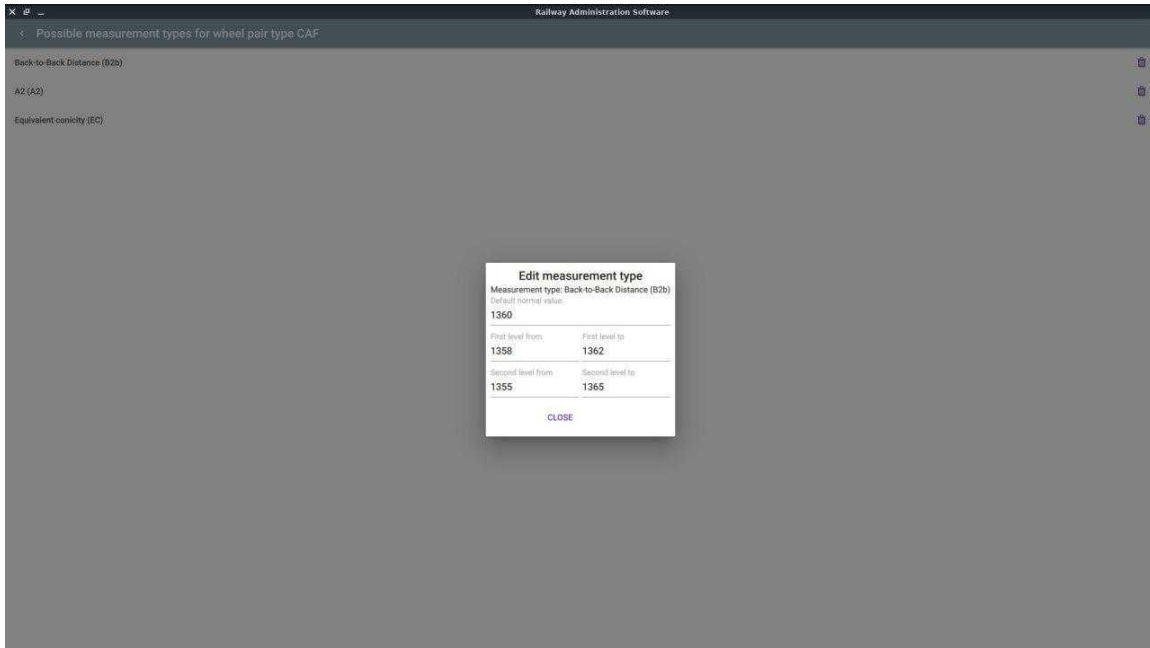

Change the values and click the **CLOSE** button, or press the **Esc** key.

To go back to the **Wheel Pair Types** tab, click the button in the upper left corner -



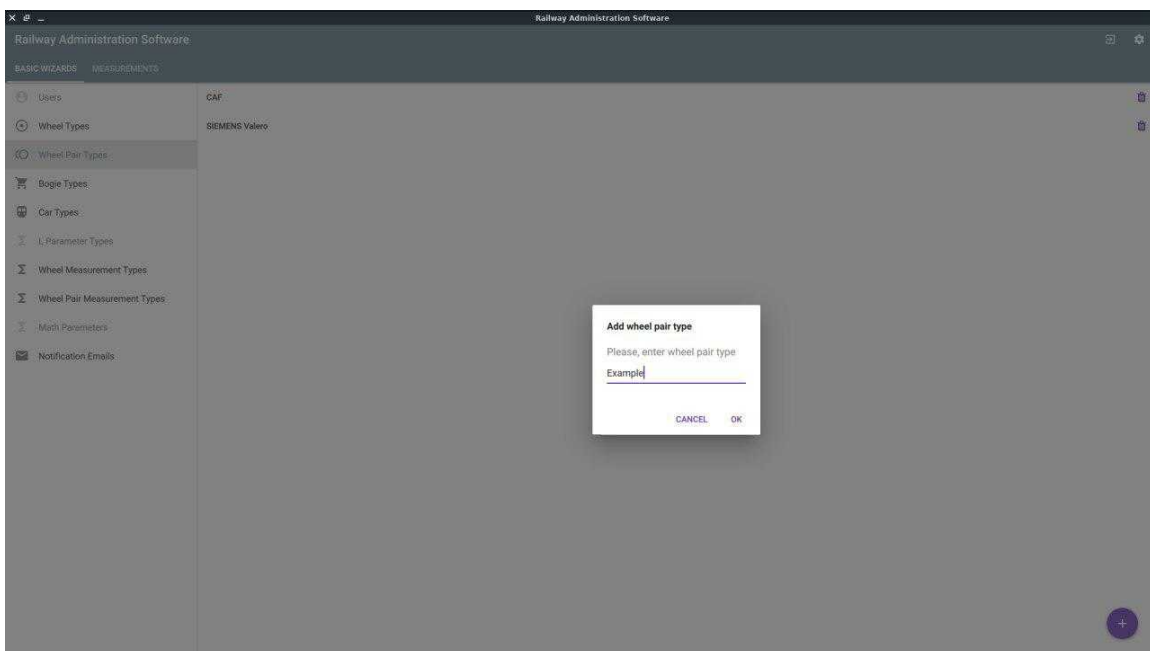

To add a new wheelset type, click the button in the lower right corner of the **Wheel**

Pair Types tab - . The following window appears:



Enter the name of a new wheelset type and click **OK**. A new wheelset type will be added to the list.

To add the measurement types for the new wheelset type, click on its name in the list, and then click .

To delete the wheelset type or the measurement type, click .

9.4.1.4. Car Types

The **Car Types** tab:

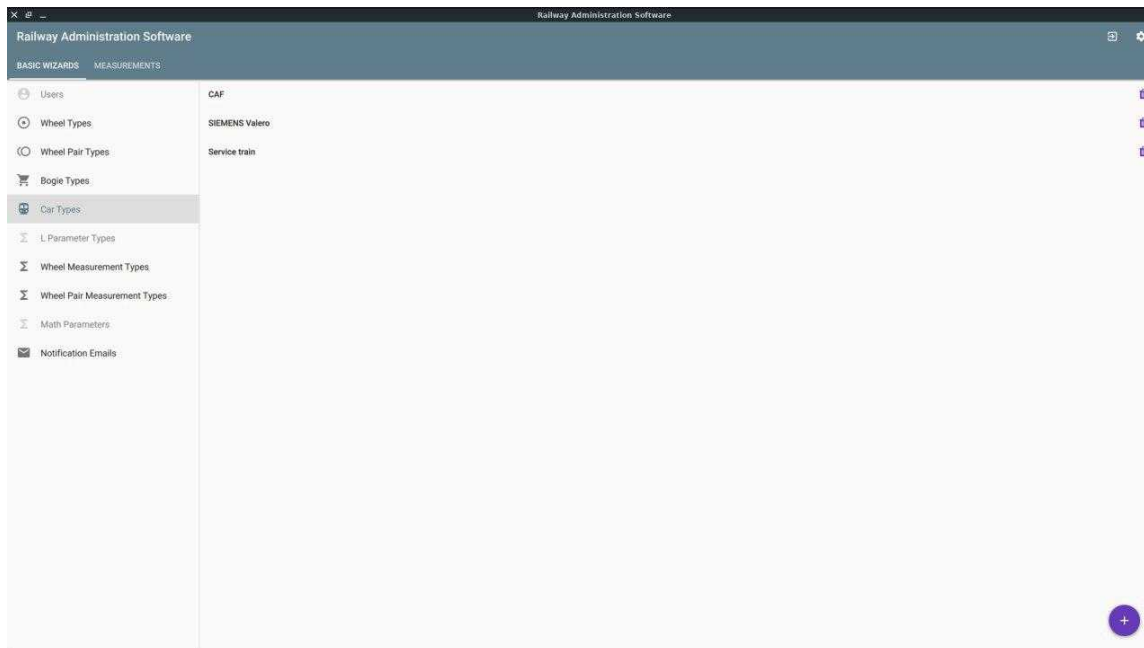

The **Car Types** tab contains a list of preset car types.

To view or edit the car type, click on its name in the list. The following window appears:

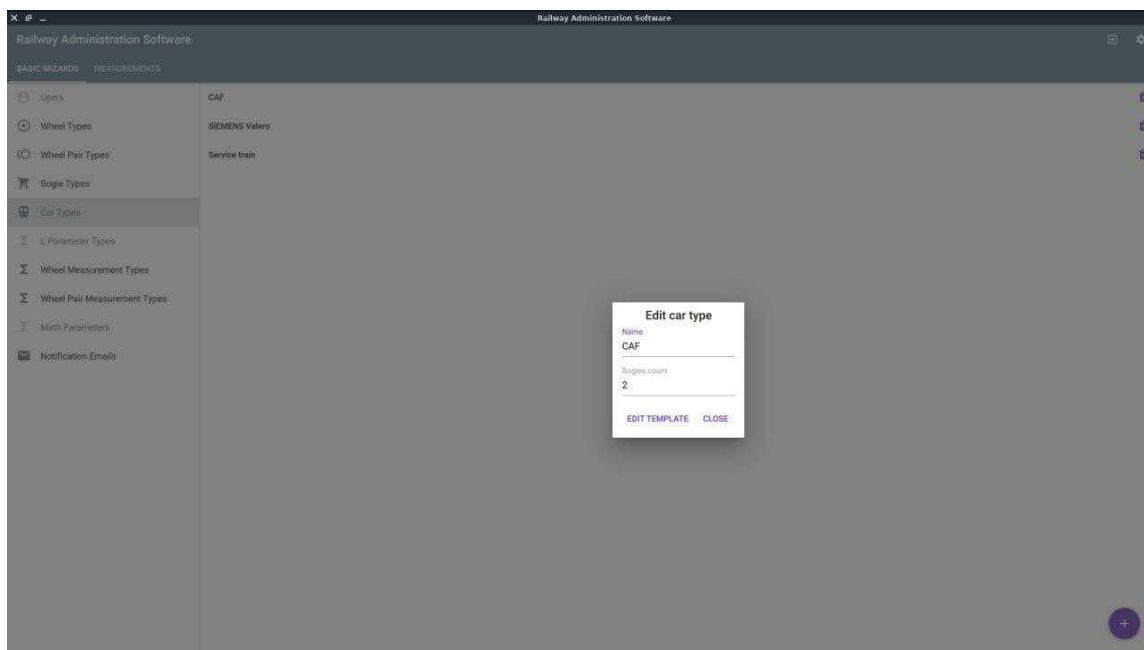

Change the values and click the **CLOSE** button, or press the **Esc** key. In this window, you also can edit the car template by clicking the **EDIT TEMPLATE** button.

To add a new car type, click the button in the lower right corner of the **Car Types** tab - . The following window appears:

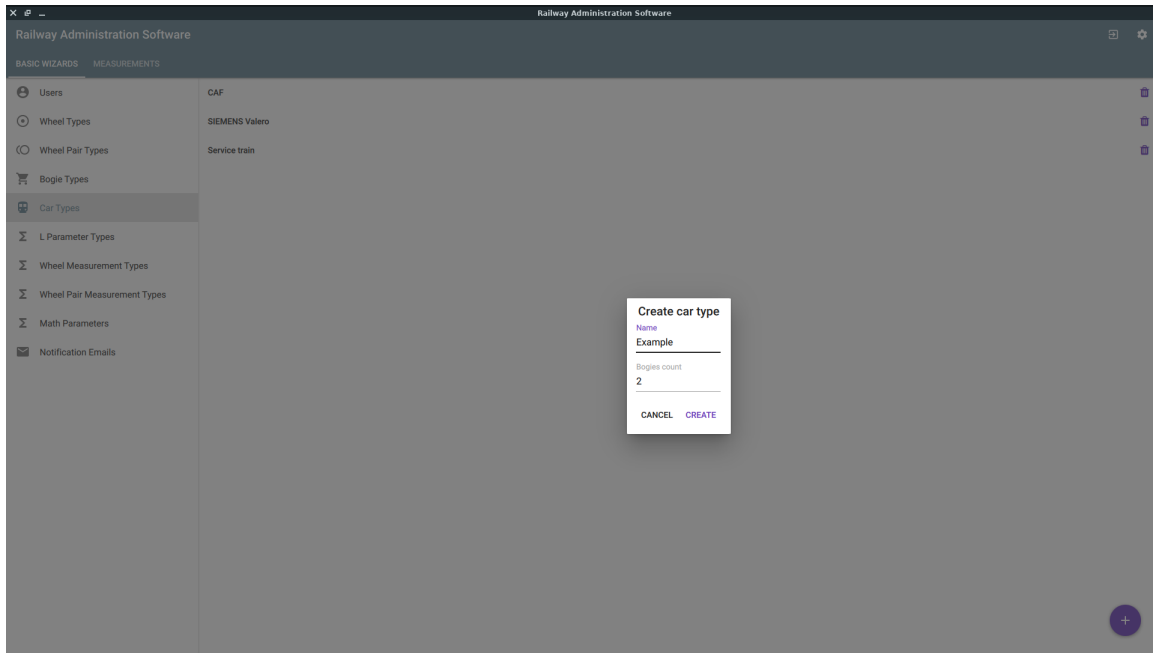

Enter the name of a new car type, the number of bogies, and click **CREATE**. A new car type will be added to the list. Then, it is necessary to add the bogies to the car template. Click on the car type name, click the **EDIT TEMPLATE** button, and then click the button in the lower right corner - .

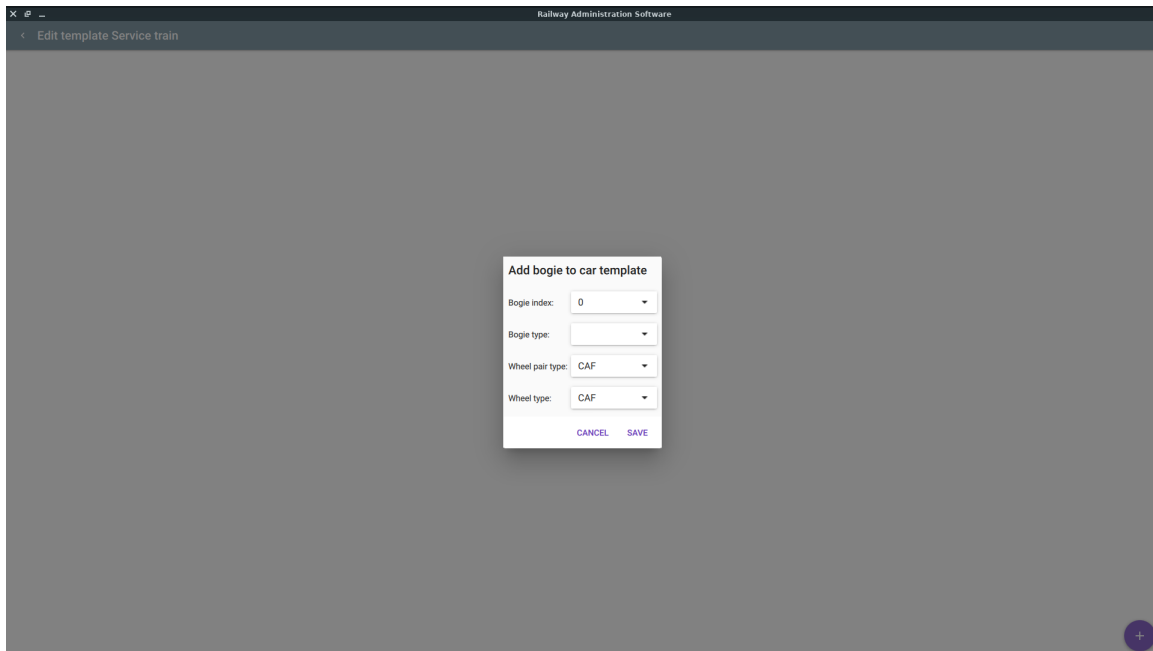

Create a bogie description and click **SAVE**. Repeat the same procedure for other bogies.

To go back to the **Car Types** tab, click the button in the upper left corner - .

To delete the car type, click .

9.4.1.5. Wheel Measurement Types

The Wheel Measurement Types tab:

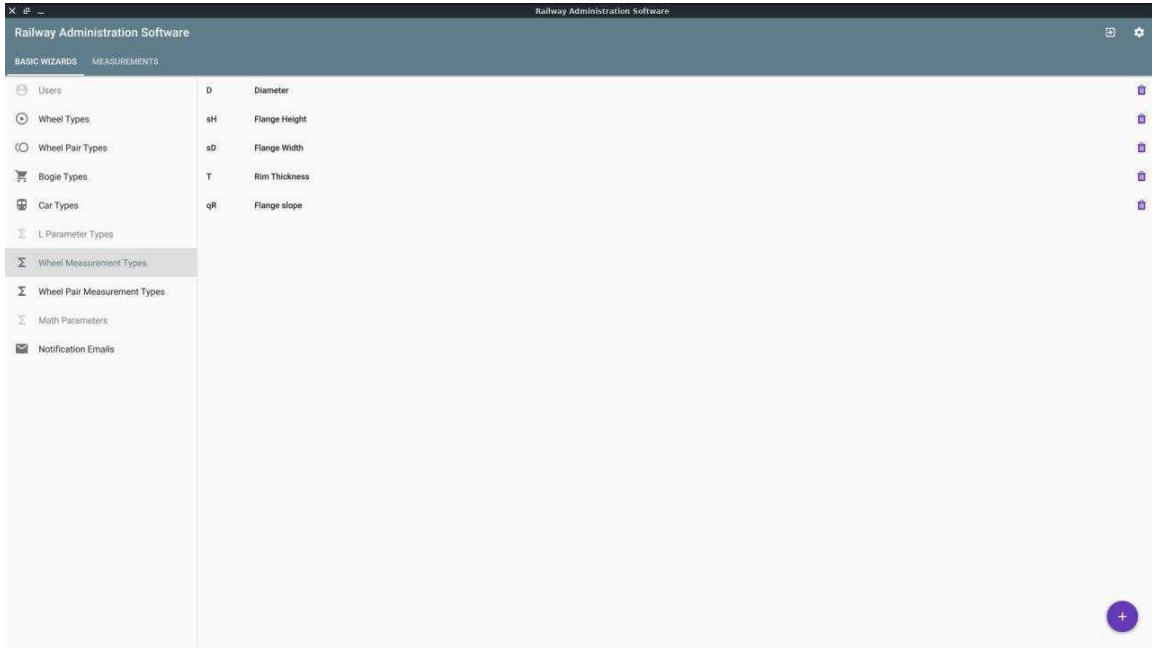

Code	Parameter	Nominal value, mm	Measurement error, mm
D	Diameter	920/850	±0.5
sH	Flange height	32	±0.18
sD	Flange width	32.5	±0.15
T	Rim thickness	60	±0.15
qR	Flange slope	10	±0.3

9.4.1.6. Wheel Pair Measurement Types

The Wheel Pair Measurement Types tab:

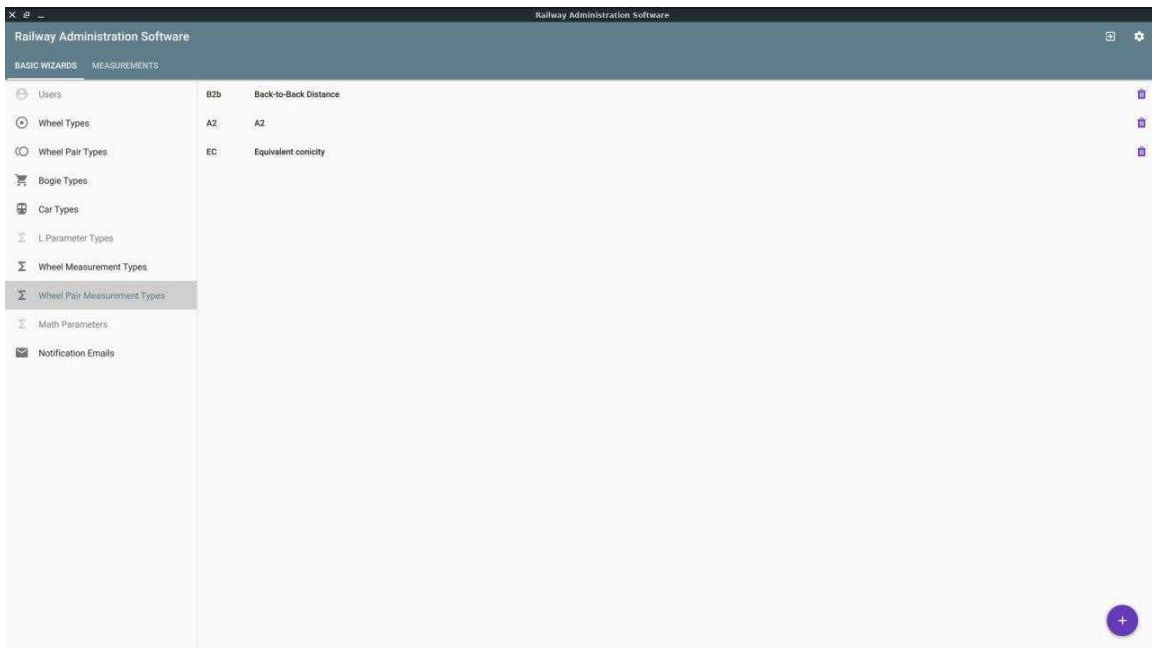

Code	Parameter	Nominal value, mm	Measurement error, mm
B2b	Back-to-back distance	1400	±0.3
A2	B2b+sD1+sD2	1464	±0.3
EC	Equivalent conicity	1	±0.2

9.4.1.7. Math Parameters

The Math Parameters tab:

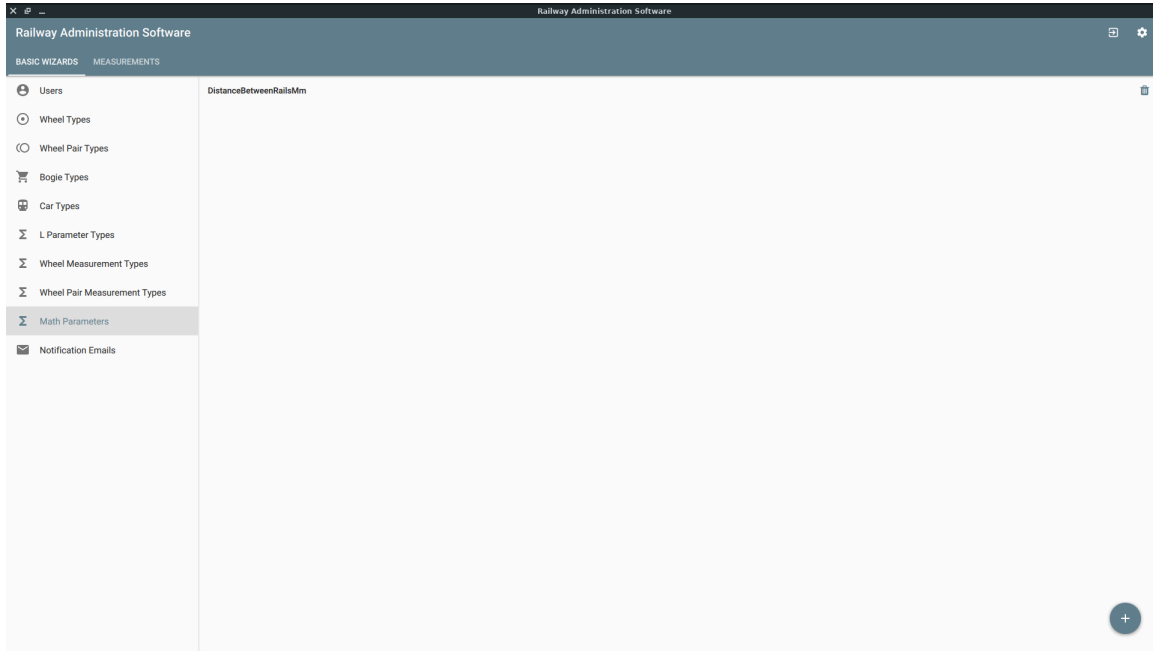

To view or edit a parameter, click on its name in the list. The following window appears:

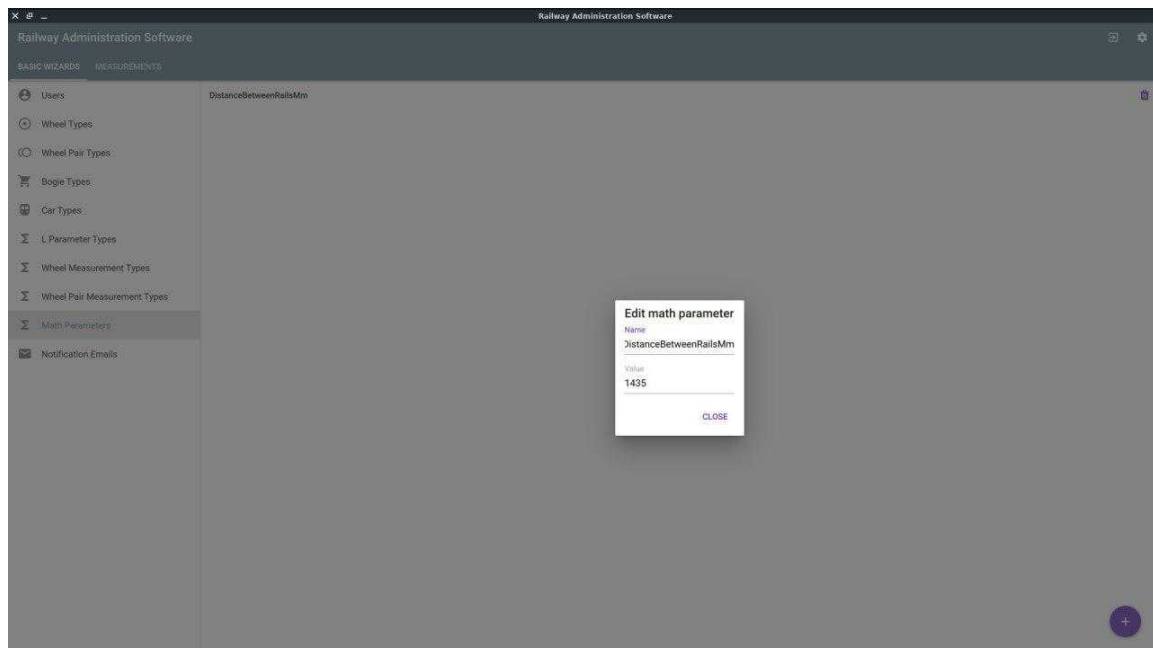

9.4.1.8. Notification Emails

The Notification Emails tab:

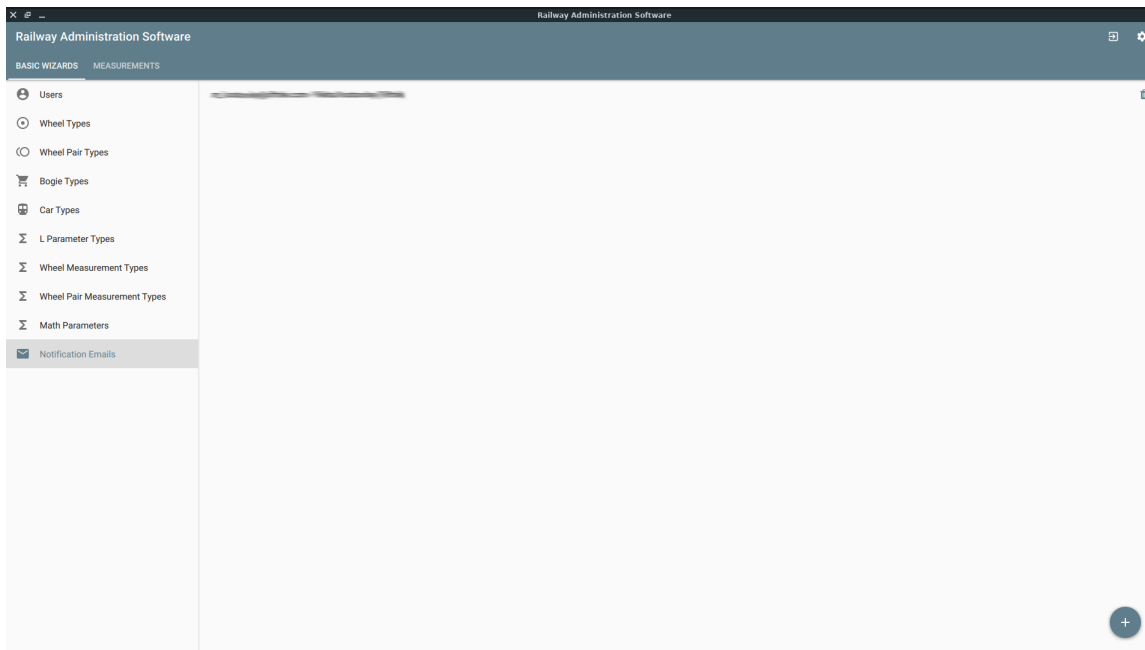

To view or edit the notification, click on it in the list. The following window appears:

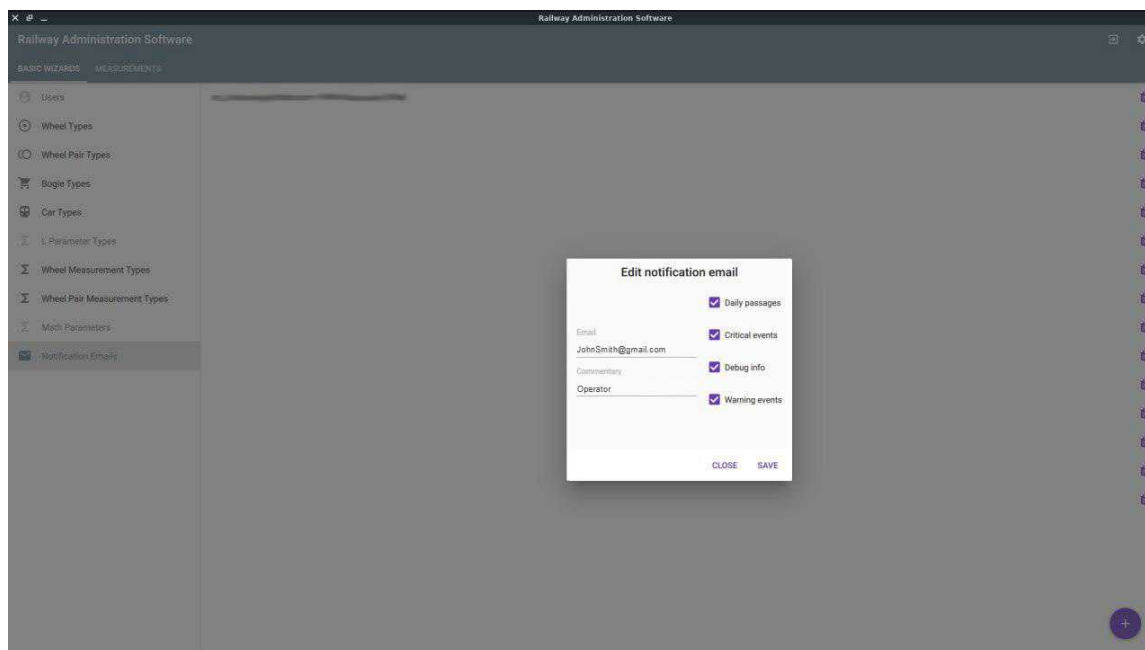

To apply changes, click **SAVE**.

To delete the notification, click .

9.4.2. "MEASUREMENTS" tab

The **MEASUREMENTS** tab contains the measurement results. The data is automatically added to the database after the train passes through the control area.

9.4.2.1. Measurement results

The measurement results can be presented in both tabular and graphical form.

9.4.2.1.1. Tabular form

To view the measurement results in tabular form, click on the train panel (circled in red):

#	Diameter (D) (Left)	Diameter (D) (Right)	Flange Height (sH) (Left)	Flange Height (sH) (Right)	Flange Width (sD) (Left)	Flange Width (sD) (Right)	Rim Width (L) (Left)	Rim Width (L) (Right)	Rim Thickness (T) (Left)	Rim Thickness (T) (Right)	Out Growth (oG) (Left)	Out Growth (oG) (Right)	Radial Runout (rO) (Left)	Radial Runout (rO) (Right)	Flange Slope (qR) (Left)	Flange Slope (qR) (Right)	Bearing t° (BT) (Left)	Bearing t° (BT) (Right)	Back-to-Back Distance (B2b)	Axial Runout (AxisRO)
1	596.6	595.2	21.6	22.4	20.2	18.6	120.9	120.9	30.8	30.1	0.1	0.1	0.1	0.1	3.4	3.9	7.2	11.5	1374.5	0.2
2	600.5	600.9	23.0	23.0	23.5	21.7	120.5	120.7	32.5	32.4	0.1	0.1	0.0	0.0	3.5	4.0	6.2	10.3	1373.6	0.1
3	596.7	597.9	23.5	23.6	22.3	21.8	120.7	120.8	30.9	31.4	0.1	0.1	0.0	0.1	4.8	4.7	4.7	9.6	1373.5	0.1
4	597.2	596.3	23.6	23.8	23.9	24.3	120.7	120.7	31.4	30.3	0.1	0.2	0.3	0.2	3.8	4.1	23.5	8.3	1374.0	0.1
5	596.2	597.0	22.1	22.7	20.4	20.0	120.6	120.6	30.7	30.6	0.2	0.1	0.1	0.5	3.9	4.2	6.6	14.0	1373.4	0.2
6	597.3	596.8	23.0	23.4	23.4	23.8	120.9	121.8	31.0	30.5	0.1	0.1	0.4	0.0	3.6	4.1	23.8	9.9	1374.2	0.2

The train panel shows the following information:

Train #1721 (6 wp) 120 0 0
11/02/2020 21:43:43, 6.9 (km/h)

- Train number – "Train #1721".
- Number of wheelsets – "6 wp".
- Number of measurements – "120 0 0" (description of colors is given below).
- Date – "11/02/2020".
- Time – "21:43:43".
- Train speed – "6.9 (km/h)".

If the measurement results are within tolerances, you will see the following icon to the left of the train panel - . If the measurement results do not fall within tolerances, you will see the following icon to the left of the train panel - .

To export data to CSV, click the button next to the train panel - .

The right panel shows the measured parameters for each wheelset (wheelset number is circled in red):

#	Diameter (D) (Left)	Diameter (D) (Right)	Flange Height (sH) (Left)	Flange Height (sH) (Right)	Flange Width (sD) (Left)	Flange Width (sD) (Right)	Rim Width (L) (Left)	Rim Width (L) (Right)	Rim Thickness (T) (Left)	Rim Thickness (T) (Right)	Out Growth (oG) (Left)	Out Growth (oG) (Right)	Radial Runout (rO) (Left)	Radial Runout (rO) (Right)	Flange Slope (qR) (Left)	Flange Slope (qR) (Right)	Bearing t° (BT) (Left)	Bearing t° (BT) (Right)	Back-to-Back Distance (B2b)	Axial Runout (AxisRO)
1	596.6	595.2	21.6	22.4	20.2	18.6	120.9	120.9	30.8	30.1	0.1	0.1	0.1	0.1	3.4	3.9	7.2	11.5	1374.5	0.2

Green color indicates that the measurement result is within the first tolerance. Yellow color indicates that the measurement result is within the second tolerance. Red color indicates that the measurement result is beyond the second tolerance. NaN - measurement failure.

9.4.2.1.2. Graphical form

To view the measurement results in graphical form, click :

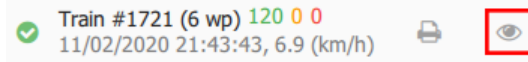

In the left panel, click on the required part of the scheme to browse the measurement results. For example:

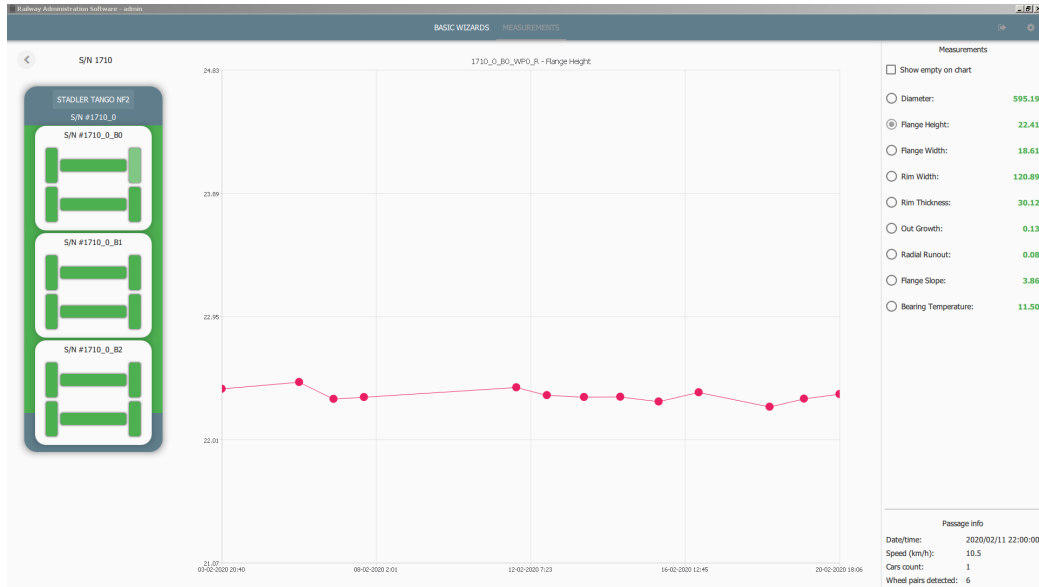

In the central panel, you can see the graphical image of the value of a particular parameter. This parameter can be selected in the right panel.

The description of colors is given in the previous paragraph.

The **Show empty on chart** checkbox shows the passages without measurements.

To go back, click the button next to the train number - .

9.4.2.2. Wheel profile

To view the wheel profile, double-click on the diameter value in the table of measurement results.

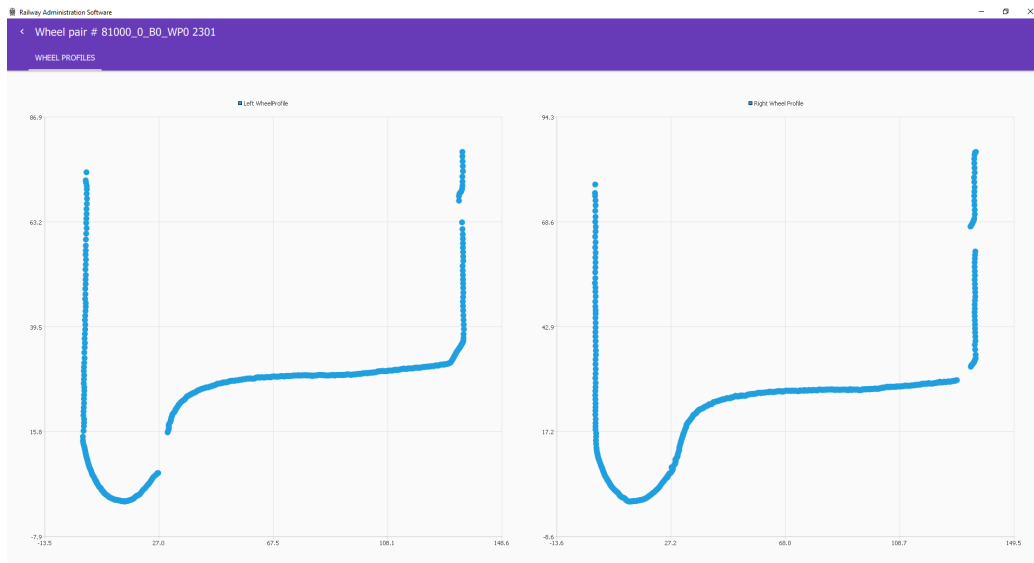

To go back, click .

9.4.2.3. Sorting and filtering

You can use the search bar to find the train by its serial number:

To apply sorting and filtering, click  and select the options:

View: Passages ▼

Sort by: Date/Time ▼

Order: Descending ▼

Show empty

Show unrecognized

Strict filter

9.5. Data export

9.5.1. Data export formats

After each measurement of the train, the measurement results are written to the database and a report is generated. The report contains the following information: the measurement date and time, the train speed, the car number, the number of wheelsets and the measured parameters. In addition, the system can provide the following data: wheel profiles, wheelsets speed, direction of wheelsets, environment temperature. Currently, the system supports three formats: CSV, XLSX, JSON. Reports are stored on the server and, if necessary, can be sent by email.

9.5.2. Examples

9.5.2.1. CSV

3DWheel Measurements								
Date: 2020/02/23								
Time: 19:59:38								
Car number: 0								
Average speed: 6.85 km/h								
#	D(L)	D(R)	sH(L)	sH(R)	sD(L)	sD(R)	qR(L)	qR(R)
1	687,3	687,98	23,64	23,1	20,45	20,49	4,41	4,02
2	688,09	686,82	22,88	24,18	23,31	24,52	3,92	4,95
3	687,11	688,52	23,73	22,94	21,51	21,04	4,44	3,89
4	688,8	687,37	22,86	23,75	23,9	24,27	3,86	4,56
5	687,08	688,03	23,57	22,93	21,9	21,43	4,49	3,97
6	688,41	688,02	22,86	23,71	24,18	24,11	4,03	4,46

9.5.2.2. XLSX

Measurements - Poruba								
Date: 2020/02/23								
Time of measurement: 19:59:38								
Average speed: 7 km/h								
Tram ID	Type	Wheel set	D(L)	D(R)	sH(L)	sH(R)	sD(L)	sD(R)
	0 CarType	1	687,3	688	23,6	23,1	20,4	20,5
		2	688,1	686,8	22,9	24,2	23,3	24,5
		3	687,1	688,5	23,7	22,9	21,5	21
		4	688,8	687,4	22,9	23,7	23,9	24,3
		5	687,1	688	23,6	22,9	21,9	21,4
		6	688,4	688	22,9	23,7	24,2	24,1

Wheel profiles are saved in separate tabs:

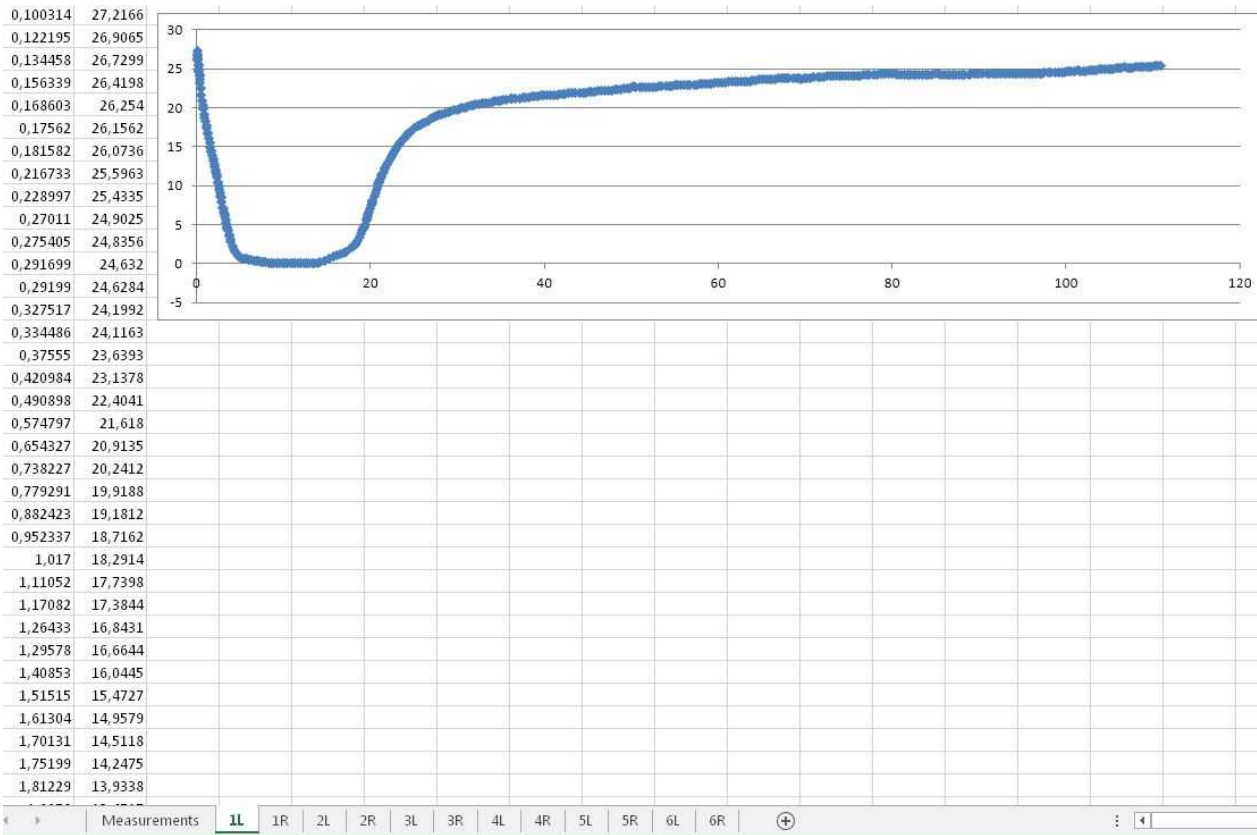

9.5.2.3. JSON

```
[
  [
    [
      [
        {
          "D": 687.3026174138828,
          "L": 120.66311325665687,
          "T": 35.02020733530675,
          "oG": 0.1164466612242025,
          "qR": 4.407366434733072,
          "rO": 0.2628764034200593,
          "sD": 20.44835354487101,
          "sH": 23.644717694211888
        },
        {
          "D": 687.9751472243917,
          "L": 120.71566376306754,
          "T": 35.45981243859366,
          "oG": 0.1358842851576091,
          "qR": 4.016982293128967,
          "rO": 0.2125430822372458,
          "sD": 20.48891031742096,
          "sH": 23.09733729179089
        }
      ],
      {
        "AxisRO": 0.34539420198188964,
        "B2b": 1375.16881266826,
        "Number": 0
      }
    ],
    ...
    ...
    ...
    [
      [
        {
          "D": 688.4073052795457,
          "L": 120.64484220838331,
          "T": 34.93728164398056,
          "oG": 0.12607032603945623,
          "qR": 4.027633367265974,
          "rO": 0.06191604669543125,
          "sD": 24.18155947185698,
          "sH": 22.85857122393622
        },
        {
          "D": 688.018169317617,
          "L": 120.67052916008655,
          "T": 35.07461368863065,
          "oG": 0.1367980419189953,
```

```

    "qR": 4.460418260097503,
    "rO": 0.07304188773745679,
    "sD": 24.109996795654297,
    "sH": 23.70566265015375
  }
],
{
  "AxisRO": 0.21475389625084063,
  "B2b": 1375.499207351858,
  "Number": 5
}
],
{
  "carId": 0,
  "carNumber": "0",
  "carType": "type",
  "chassisType": "type",
  "wheelsetCount": 6
}
],
{
  "dateTime": "2020-02-23T19:59:38",
  "ok": true,
  "speed": 7,
  "version": 2
}
]

```

9.6. Prediction of repair date

The program can predict the date of repair. The time period for which it is necessary to make a prediction is set by the user. In the screenshot below, the point circled in green is the predicted date of repair (time period - 6 months).

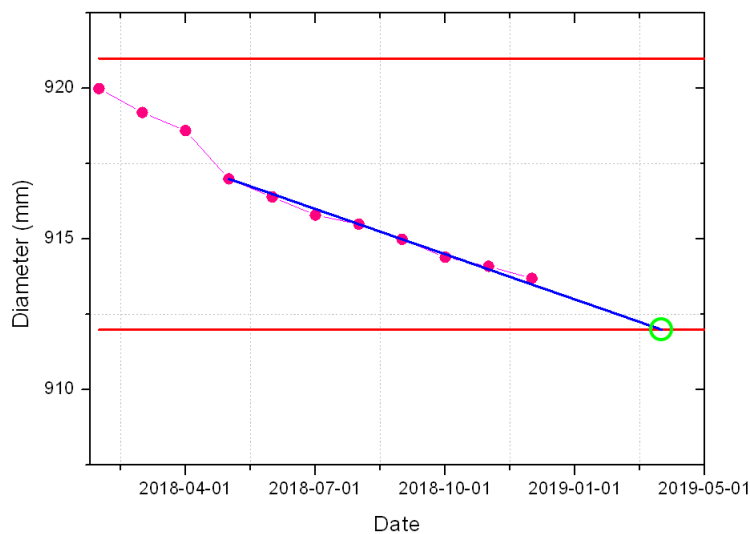

In order for the program to calculate the date of the next repair, it is necessary to follow the instructions below:

- 1) Set valid values for parameters that need to be controlled. See par. [9.4.1.2.](#) and par. [9.4.1.3.](#)

- 2) In the settings, set the time period for which it is necessary to make a prediction. It is recommended to set at least 6 months.
- 3) Set the number of weeks before the repair date when the program should send a notification.
- 4) Add the email address to which the repair notifications should come. See par. [9.4.1.8.](#)

NOTE: If the measurement period is less than the prediction period specified in the settings, the repair notifications will not come.

Notification example:

Subject

3DWheel 007 (Mukundpur Depot): @train_number@

Text

Train #1: @train_number@ (@chasi_type@) Wheelsets: 24

Timestamp (local time): 2020-03-31T00:14:54

Detected wheelsets: 24 (Expected: 24)

Average speed: 15.5 km/h

Math ok/valid results: YES

Valid passage/logged to DB: YES

Environment temp: 4

Repair prediction

1) Wheelset number: 2

Wheel: A

Parameter: sH(Flange height)

Out of tolerance in less 1 week

2) Wheelset number: 10

Wheel: B

Parameter: sD(Flange width)

Out of tolerance in less 2 week

9.7. Program settings

Click the button in the upper right corner of the main window - . The **Settings** window will appear:

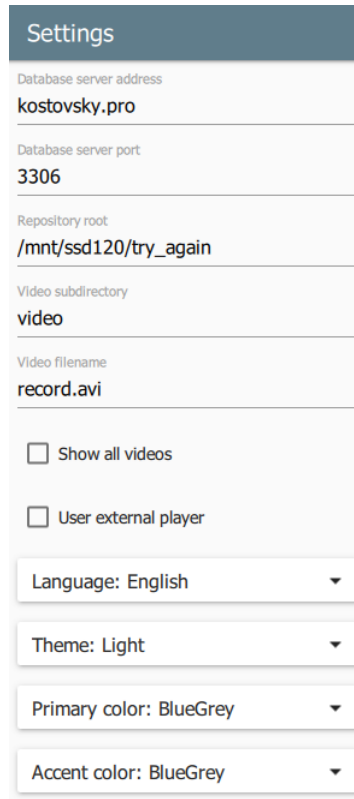

The screenshot shows a 'Settings' window with the following fields and options:

- Database server address: kostovsky.pro
- Database server port: 3306
- Repository root: /mnt/ssd120/try_again
- Video subdirectory: video
- Video filename: record.avi
- Show all videos
- User external player
- Language: English (dropdown)
- Theme: Light (dropdown)
- Primary color: BlueGrey (dropdown)
- Accent color: BlueGrey (dropdown)

Field / Option	Description
Database server address	Enter the address and port of the database server.
Database server port	
Repository root	Enter a path to the repository.
Video subdirectory	Enter the name of the video files directory.
Video filename	Enter the name of video files.
Show all videos	Display the "Video" icons in the "Measurements" tab for every train. Note: If there is no video files directory on the computer, the "Video" icons will not be displayed.
User external player	Select this option if you run the RAS software on Windows, because in this case the embedded video player doesn't work.
Language	Select the program language.
Theme	Select the theme: Light or Dark.
Primary color	Select the primary color (the tabs bar).
Accent color	Select the accent color (buttons, checkboxes).

9.8. Keyboard shortcuts

Ctrl + Page Up Ctrl + Page Down	Switching between the items in the list.
Ctrl + N	Create a new item.
Ctrl + Q	Close the software application.
Esc	Go back to the main window.

10. Riftek API

Connection through REST requests:

http://railway.riftek.com:5000/INSTALLATION_NAME/trains/TRAIN_SN/passages/

[atest](#)

Below is a response to a request for measurements in JSON format (train serial number - "TRAIN_SN", in the system - "INSTALLATION_NAME"):

```
{
  "train_pasage": {
    "date_time": "2020-01-31 06:57:24",
    "orientation": "Forward",
    "speed_km_h": 4.8,
    "detected_wheel_pairs_count": 4,
    "train": {
      "serial_number": "1256",
      "cars": [
        {
          "serial_number": "1256_0",
          "index_number": 0,
          "orientation": "Forward",
          "car_type": "Inekon TRIO",
          "bogies": [
            {
              "serial_number": "1256_0_0",
              "index_number": 0,
              "orientation": "Forward",
              "wheel_pairs": [
                {
                  "serial_number": "1256_0_0_0",
                  "index_number": 0,
                  "orientation": "Forward",
                  "measurements": [
                    {
                      "type": "b2b",
                      "value": 1371.57
                    }
                  ],
                },
              ],
            },
            {
              "left_wheel": {
                "measurements": [
                  {
                    "type": "d",
                    "value": 554.262
                  }
                ],
              },
              {
                "type": "l",

```

11. Annex 1. Controller RF700

47

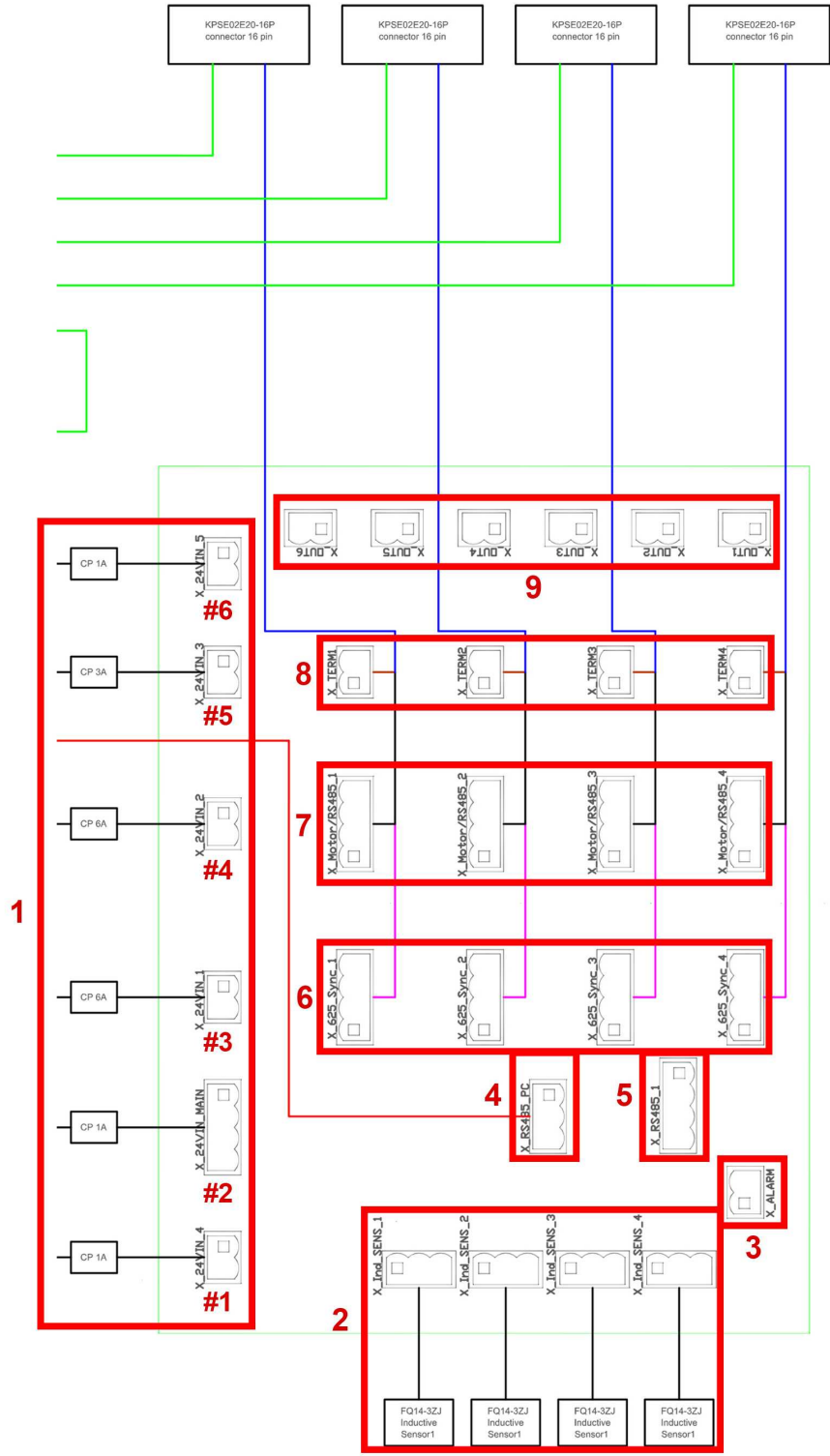

Description:

1	External power supply: #1 - Inductive sensors #2 - RF700 #3 - S LAN #4 - Motor #5 - Heating #6 - External devices
2	Inductive sensors
3	Measurement signal
4	Server PC
5	Motor control
6	Scanner sync & power
7	Protective shutters power
8	Heating
9	External devices

12. Warranty policy

Warranty assurance for the Real Time Wheels Geometry Measurement System 3DWheel Series – 24 months from the date of putting in operation; warranty shelf-life – 12 months.

13. Revisions

Date	Revision	Description
17.01.2020	1.0.0	Starting document.
31.03.2020	1.1.0	1. Updated par. 6.3. "Position monitoring module". 2. Updated par. 6.4. "Identification module". 3. Updated par. 7.2. "Measured parameters". 4. Added data export examples (csv, xlsx, json).
16.09.2020	1.2.0	Updated par. 6.1. "Laser scanning modules".

14. Distributors

AUSTRALIA

**Applied Measurement
Australia Pty Ltd**
RAILWAY INSTRUMENTS ONLY
Thornton Plaza, Unit 5,
27 Thornton Crescent, Mitcham
VIC 3132, Australia
Tel: +61 39874 5777
Fax: +61 39874 5888
sales@appliedmeasurement.com.au
www.appliedmeasurement.com.au

BENELUX

Althen Sensors & Controls BV
Viertelweg 17a, 2266KA
Leidschendam
The Netherlands
Tel: +31 70 3924421
Fax: +31 70 3644249
sales@althen.nl
www.althensensors.com
www.althencontrols.com

BOSNIA AND HERZEGOVINA

RMT Ltd.
Zahradni 224, 739 21
Paskov, Czech Republic
Tel: +420 558640211
Fax: +420 558640218
rmt@rmt.cz
www.rmt.cz

BRAZIL**CAPI Controle e Automação Ltda**

Rua Itororó, 121, CEP 13466-240
Americana-SP, Brazil
Tel: +55 19 36047068
Fax: +55 19 34681791
capi@capicontrol.com.br
www.capicontrol.com.br

CHINA**Beijing Gemston Mechanical & Electrical Equipment Co., Ltd**

Room 613, Anfu Mansion, Fengtai District, Beijing, China
Tel: +86 10 6765 0516
Fax: +86 10 6765 6966
Mobile: +86 137 1755 1423
dh0526@163.com
www.baof.cn

CHINA**Zhenshangyou Technologies Co., Ltd.**

Rm 2205-2210, Zhongyou Hotel 1110 Nanshan Road, Nanshan District 518054 Shenzhen, China
Tel: +86 755-26528100/8011/8012
Fax: +86 755-26528210/26435640
info@51sensors.com
www.51sensors.com

ESTONIA**RD Resolve OU**

Punane 14a-304
Tallinn, 13619, Estonia
Tel: +3726206506
rdresolv@gmail.com

FRANCE**BLET Measurement Group S.A.S.**

1 avenue du Président Georges Pompidou, 92500 Rueil Malmaison, France
Tel: + 33(0)1 80 88 57 85
Fax: +33(0)1 80 88 57 93
technique@blet-mesure.fr
www.blet-mesure.fr

BULGARIA**RMT Ltd.**

Zahradni 224, 739 21 Paskov, Czech Republic
Tel: +420 558640211
Fax: +420 558640218
rmt@rmt.cz
www.rmt.cz

CHINA**Xi'an Win-Success Automation Technology Co.,Ltd**

Room 3-1-1039, Iduhui Building, No.11 Tangyan South Road High-Tech Zone, Xi'an Shaanxi PRC, China
Tel: +86-29-81106280
Fax: +86-29-81106285
Mob: +86-133-1927-1405
info@maxsensor.com
www.maxsensor.com

CROATIA, CZECH REPUBLIC**RMT Ltd.**

Zahradni 224, 739 21 Paskov, Czech Republic
Tel: +420 558640211
Fax: +420 558640218
rmt@rmt.cz
www.rmt.cz

FINLAND**Kvalitest Industrial Oy EXCEPT FOR RAILWAY INSTRUMENTS**

Punasillantie 31 A, 40950 Muurame, Finland
Tel: +358 0 20 730 6070
sales@kvalitest.com
www.kvalitest.com
www.kvalitest.fi

GERMANY**Disynet GmbH**

Breyeller Str. 2, 41379 Brueggen, Germany
Tel: +49 2157 8799-0
Fax: +49 2157 8799-22
disynet@sensoren.de
www.sensoren.de

CHILE**Verne SpA**

Apoquindo 2818, oficina 31 Las Condes, Santiago, Chile
Tel: +56 2 228858633
info@verne.cl
jsaavedra@verne.cl
www.verne.cl

CHINA**Micron-Metrology co., ltd**

No.2, Kecheng Rd., Industrial Park District, Suzhou, Jiangsu Province, China
Tel: +86 189 1806 9807
sales@micron-metrology.cn
www.micron-metrology.cn

DENMARK**BLConsult**

Ryssbält 294
95 291 Kalix, Sweden
Tel: +46 70 663 19 25
info@blconsult.se
www.blconsult.se

FINLAND**TERÄSPYÖRÄ-STEELWHEEL OY**

RAILWAY INSTRUMENTS ONLY
Juvan teollisuuskatu 28
FI-02920 ESPOO, Finland
Tel: +358 400 422 900
Fax: +358 9 2511 5510
steelwheel@steelwheel.fi
www.teraspyora.fi

GERMANY**Finger GmbH & Co. KG**

OPTICAL MICROMETERS ONLY
Sapelloh 172, 31606 Warmen, Germany
Tel: +49 5767 96020
Fax: +49 5767 93004
finger@finger-kg.de
www.finger-kg.de

GERMANY**Hylewicz CNC-Technik**
SHTRIKH-2 ONLY

Siemensstrasse 13-15
47608 Geldern, Germany
Tel: +49 2831 91021-20
Fax: +49 2831 91021-99
info@cnc-step.de
www.cnc-step.de

INDIA**Influx Big Data Solutions Pvt Ltd**

No:2, Krishvi, Ground Floor,
Old Airport Road, Domlur,
Bangalore - 560071, India
Tel: +91 73 37748490
Tel: +91 94 48492380
milan@influxtechnology.com
support_india@influxtechnology.com
www.influxtechnology.com

IRAN**Novin Industrial Development Grp.**

Tel: +98 21 44022093-6
Fax: +98 21 43858794
Mobile: +98 9123207518
info@novinid.com
www.novinid.com

JAPAN**Tokyo Instruments, Inc.**

6-18-14 Nishikasai, Edogawa-ku,
Tokyo, 134-0088 Japan
Tel: +81 3 3686 4711
Fax: +81 3 3686 0831
f_kuribayashi@tokyoinst.co.jp
www.tokyoinst.co.jp

MONTENEGRO**RMT Ltd.**

Zahradni 224, 739 21
Paskov, Czech Republic
Tel: +420 558640211
Fax: +420 558640218
rmt@rmt.cz
www.rmt.cz

GERMANY**ALTHEN GmbH Meß- und Sensortechnik**

Dieselstrasse 2, 65779
Kelkheim, Germany
Tel: +49 0 6195 7 00 60
info@althen.de
www.althensensors.com/de/

INDIA**Paragon Instrumentation Engineers Pvt. Ltd.**

RAILWAY INSTRUMENTS ONLY
200, Station Road,
Roorkee, 247 667, India
Tel: +91-1332-272394
tanuj@paragoninstruments.com
www.paragoninstruments.com

ISRAEL**Nisso Dekalo Import Export LTD**

1 David Hamelech Street
Herzlia 46661 Israel
Tel: +972-99577888
Fax: +972-99568860
eli@fly-supply.net
www.fly-supply.net
www.aircraft-partsupply.com

LATVIA**SIA "SOLARTEX"**

RAILWAY INSTRUMENTS ONLY
Duntes 15a, 5th floor, office B7
Riga, Latvia
Tel: +371 67 130 787
solartex@inbox.lv

NORWAY**BLConsult**

Ryssbält 294,
95 291 Kalix, Sweden
Tel: +46 70 663 19 25
info@blconsult.se
www.blconsult.se

HUNGARY**RMT Ltd.**

Zahradni 224, 739 21
Paskov, Czech Republic
Tel: +420 558640211
Fax: +420 558640218
rmt@rmt.cz
www.rmt.cz

INDONESIA**PT. DHAYA BASWARA SANIYASA**

Botanic Junction Blok H-9 NO. 7
Mega Kebon Jeruk, Joglo
Jakarta 11640, Indonesia
Tel: + 62 21 29325859
management@ptdbs.co.id

ITALY**FAE s.r.l.**

Via Tertulliano, 41
20137 Milano, Italy
Tel: +39-02-55187133
Fax: +39-02-55187399
fae@fae.it
www.fae.it

MALAYSIA**OptoCom InstruVentures**

H-49-2, Jalan 5, Cosmoplex
Industrial Park, Bandar Baru
Salak Tinggi, Sepang, Malaysia
Tel: 603 8706 6806
Fax: 603 8706 6809
optocom@tm.net.my
www.optocom.com.my

NORWAY**Salitec AS**

PB 468, N-1327
Lysaker, Norway
Tel: +47 23 891015
Fax: +47 92101005
mail@salitec.no
www.salitec.no

PERU

Verne Perú S.A.C.
Las Codornices 104,
Surquillo, Lima, Peru
Tel/fax: +51 992436734
info@verne.cl
www.verne.cl

POLAND

MTL ASCO Sp. z o.o.
RAILWAY INSTRUMENTS ONLY
ul. Wielowiejska 53, 44-120
Pyskowice, Poland
Tel: + 48 32 230 45 70
Fax: + 48 32 332 70 14
rail@ascorail.eu
www.ascorail.eu

PORTUGAL

**Campal Inovacoes
Ferroviarias Lda.**
RAILWAY INSTRUMENTS ONLY
Lagoas Park, Edificio 7, 1° Piso
Sul 2740-244 Porto Salvo,
Oeiras, Portugal
Tel: +351 21 584 4348
campal@campal.pt
www.campal.pt

RUSSIA

Aliance, LLC
Plehanova, 4A, 10 floor, office 1,
111123, Moscow, Russia
Tel: +7 495 741-5915
info@stankialiance.ru
www.stankialiance.ru

RUSSIA

**Group company
SpecAvtoEngineering
SPEKTR KSK**
**AUTOMATED SYSTEMS FOR
WHEELSETS GEOMETRY
CONTROL**
Electrozavodskaya str., 27, bld. 3D,
107023, Moscow, Russia
Tel: +7 485 225 75 57
Tel/Fax: +7 495 782 14 21
Tel/Fax: +7 495 782 14 21
mail@sai-holding.ru
www.sai-holding.ru
www.spektrksk.ru

RUSSIA

Intellect-Optic LLC
620078, Mira str. 32 -120
Ekaterinburg, Russia
Tel/Fax: +7 343 2227565
Tel/Fax: +7 343 2227370
pesterev@d-test.ru
www.d-test.ru

RUSSIA

Sensorika-M LLC
Dmitrovskoye shosse 64-4
127474, Moscow, Russia
Tel: +7 499 487 0363
Fax: +7 499 487 7460
info@sensorika.com
www.sensorika.com

**SERBIA, SLOVAKIA,
SLOVENIA**

RMT Ltd.
Zahradni 224, 739 21
Paskov, Czech Republic
Tel: +420 558640211
Fax: +420 558640218
rmt@rmt.cz
www.rmt.cz

SOUTH KOREA

BS Holdings
B-201, Wonpogongwon 1ro,
59 Danwon-gu, Ansan-si,
Gyeonggi-do, 15455,
Republic of Korea
Tel: +82-31-411-5011
Fax: +82-31-411-5015
bsh5011@hanmail.net
www.lasersolution.co.kr

SOUTH KOREA

PROSEN. CO., LTD
M-1001, Songdo techno park IT
center, 32, Songdogwahak-ro,
Yeonsu-gu, Incheon, 21984,
Republic of Korea
Tel: +82-32-811-3457
Fax: +82-32-232-7458
trade@prosen.co.kr
www.prosen.co.kr

SPAIN

Iberfluid Instruments S.A.
C/ Botanica, 122, 08908
L'Hospitalet de Llobregat
Barcelona
Tel: +34 93 447 10 65
Fax: +34 93 334 05 24
myct@iberfluid.com
www.iberfluid.com

SWEDEN

BLConsult
Ryssbält 294,
95 291 Kalix, Sweden
Tel: +46 70 663 19 25
info@blconsult.se
www.blconsult.se

SWEDEN**Kvalitest Industrial AB**
EXCEPT FOR RAILWAY
INSTRUMENTS

Ekbacksvägen 28,
16869 Bromma, Sweden
Tel: +46 0 76 525 5000
sales@kvalitest.com
www.kvalitest.com
www.kvalitest.se

TURKEY**MAK Elektronik Malzeme**
Analiz ve Kalite Kontrol
Cihazlari Dis Tic. Ltd. Sti.

Cenap Sahabettin Sokak, No:39,
34718 Kosuyolu - Kadikoy /
Istanbul - TURKEY
Tel: +90 216 402 10 34
Fax: +90 216 402 10 35
ulasac@metalografi.net
www.makelektronik.com.tr

**UNITED KINGDOM,
IRELAND****Ixthus Instrumentation Ltd**

The Stables, Williams' Barns
Tiffield road, Towcester,
Northants, UK
Tel: +44 1327 353437
Fax: +44 1327 353564
info@ixthus.co.uk
www.ixthus.co.uk

USA, CANADA, MEXICO**International Electronic**
Machines Corporation
RAILWAY INSTRUMENTS ONLY

850 River Street, Troy,
New York, USA
Tel: +1 518 268-1636
Fax: +1 518 268-1639
marketing@iem.net
www.iem.net

SWITZERLAND**ID&T GmbH**

Gewerbestrasse 12/a
8132 Egg (Zurich), Switzerland
Tel: + 41 44 994 92 32
Fax: + 41 44 994 92 34
info@idtlaser.com
www.idtlaser.com

TURKEY**TEKMA Mühendislik A.S.**

Cevizli Mh. M. Kemal Cd.,
Hukukçular Towers,
A-Blok, No: 66-A/39
Kartal - Istanbul
Tel: +90 216 970 1318
Tel: +90 850 840 2334
info@tekma.eu
www.tekma.eu

USA, CANADA**Althen Sensors and Controls**

2531 Bradley St.,
Oceanside, CA, 92056, USA
Tel: 858 633 3572
r.ream@althensensors.com

THAILAND**Advantech Solution Co.,Ltd.**

20/170 Motorway Rd.,
Kwang Pravet, Khet Pravet,
Bangkok, Thailand 10250
Tel: +662-1848705
Fax: +662-1848708
sales@advantechsolution.com
www.advantechsolution.com

UKRAINE**KODA**

Frunze st. 22, 61002,
Harkov, Ukraine
Tel/Fax: +38 057 714 26 54
mail@koda.com.ua
www.koda.com.ua

USA, CANADA, MEXICO**Acuity Products of Schmitt**
Industries, Inc.

2765 NW Nicolai Street
Portland, OR, 97210, USA
Tel: +1 503 227 7908
Fax: +1 503 223 1258
sales@acuitylaser.com
www.acuitylaser.com

15. RIFTEK's measurement devices for railway transport

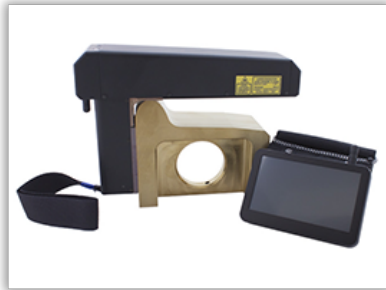

Laser wheel profilometer. IKP Series

A laser profilometer is designed for the measuring of:

- wheel flange height;
- wheel flange thickness;
- wheel flange slope;
- full profile scanning and analyze of wheel rolling surface;
- maintaining of electronic wear data base;
- control of tolerances and sorting in the course of checkup, examination, repair and formation of railway wheel sets.

Measurements are made directly on rolling stock without wheel set roll-out.



Portable laser rail profilometer. PRP Series

The main functions of PRP are:

- obtaining the information on the cross-section profile of the working railhead surface;
- full profile scanning and analyze of the railhead acting face;
- visualization of the combined graphical images of actual and new cross-section railhead profiles on the display of system unit.



Wheel diameter measuring gauge. IDK Series

Electronic gauge is designed for measuring wheel rolling circle diameter of railway, metro and tram wheel sets.

Measurements are made directly on rolling stock without wheel set roll-out.



Back-to-back distance measuring gauge. IMR Series

Gauge is designed for contactless measuring of back-to-back distance of railway, metro and tram wheels in the course of checkup, examination, repair and formation of wheel sets.

Measurements are made directly on rolling stock without wheel set roll-out.



Back-to-back distance measuring gauge. IMR-L Series

Gauge is designed for contactless measuring of back-to-back distance of railway, metro and tram wheels in the course of checkup, examination, repair and formation of wheel sets.

Measurements are made directly on rolling stock without wheel set roll-out.



Disc brakes profile gauge, IKD Series

Laser disc brakes profilometer IKD Series is designed for disc brakes profile measuring.

The main functions of IKD are:

- obtaining the information on the profile parameters of the working disc brakes surface;
- full profile scanning and analyze of the disc brakes acting face;
- visualization of the combined graphical images of actual and new disc brakes profiles on the display of system unit.



Automatic real-time system for measurement of wheelsets geometrical parameters

The system is designed for contactless automatic measurement of geometrical parameters of railway wheels and uses a combination of 2D laser scanners, mounted wayside in the track area.

The system can be easily installed at any type of rail infrastructure.